



E-BIKES

TRANSLATION OF THE ORIGINAL
OPERATING INSTRUCTIONS

EN

E-Core Evo AM RS Di2 27,5, E-Core Evo Di2 27,5+,
E-Core Evo Di2 29, E-Core Evo AM Di2, E-Core Evo EN Di2,
E-Core Evo 2 27,5+, E-Core Evo TR2, E-Core Evo 2 29

19-18-4022, 19-18-4027, 19-18-4028, 19-18-4023, 19-19-4001, 19-18-4025, 19-18-4024,
19-18-4028

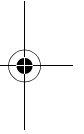
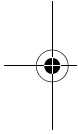
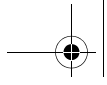

Copyright

© ZEG Zweirad-Einkaufs-Genossenschaft eG

Distribution or reproduction of these operating instructions and utilisation or communication of their content is prohibited unless expressly approved. Any infringement will render the offender liable for compensation. All rights reserved in the event that a patent, utility model or industrial design is registered.

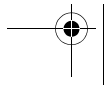
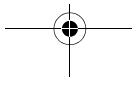



Data sheet

Surname, first name of the purchaser:

Date of purchase:

Model:

Frame number:

Type number:

Unladen weight (kg):

Tyre size:

Recommended tyre pressure (bar)*: front: rear:

Wheel circumference (mm):

Company stamp and signature:

*After a tyre change, refer to the tyre markings for the permitted tyre pressures and make sure that they are observed. The recommended tyre pressure must not be exceeded.



Table of contents

| | | |
|----------|--|-----------|
| 1 | About these instructions | 9 |
| 1.1 | Manufacturer | 9 |
| 1.2 | Laws, standards and directives | 10 |
| 1.3 | Other valid documents | 10 |
| 1.4 | Subject to change | 11 |
| 1.5 | Language | 11 |
| 1.6 | For your safety | 12 |
| 1.6.1 | Instruction, training and customer service | 12 |
| 1.6.2 | Basic safety notes | 13 |
| 1.6.3 | Warnings | 13 |
| 1.6.4 | Safety markings | 14 |
| 1.7 | For your information | 14 |
| 1.7.1 | Instructions for actions | 14 |
| 1.7.2 | Information on the type plate | 15 |
| 1.7.3 | Language conventions | 16 |
| 1.8 | Type plate | 18 |
| 1.9 | Identifying | 19 |
| 1.9.1 | Operating instructions | 19 |
| 1.9.2 | Bicycle | 19 |
| 2 | Safety | 20 |
| 2.1 | Requirements for the rider | 20 |
| 2.2 | Hazards for vulnerable groups | 20 |
| 2.3 | Personal protective equipment | 20 |
| 2.4 | Proper use | 21 |
| 2.4.1 | Mountain bike | 21 |
| 2.5 | Improper use | 22 |
| 2.5.1 | Mountain bike | 23 |
| 2.6 | Duty to take care | 23 |
| 2.6.1 | Operator | 23 |
| 2.6.2 | Rider | 24 |
| 3 | Description | 25 |
| 3.1 | Overview | 25 |
| 3.2 | Handlebars | 26 |
| 3.3 | Wheel and fork | 27 |
| 3.3.1 | Valve | 27 |
| 3.3.2 | Suspension | 29 |
| 3.3.3 | Suspension fork structure | 30 |

Table of contents

| | | |
|----------|---|-----------|
| 3.3.3.1 | Air suspension fork structure | 31 |
| 3.3.3.2 | Structure of the FOX rear frame damper | 32 |
| 3.3.3.3 | Structure of the Suntour rear frame damper | 33 |
| 3.4 | Brake system | 34 |
| 3.5 | Electric drive system | 35 |
| 3.5.1 | Rechargeable battery | 37 |
| 3.5.1.1 | Battery charge status indicator | 39 |
| 3.5.2 | Driving light | 39 |
| 3.5.3 | Display | 40 |
| 3.5.3.1 | Gear indicator | 41 |
| 3.5.3.2 | System message | 41 |
| 3.5.3.3 | Battery charge status indicator | 42 |
| 3.5.3.4 | Journey information | 43 |
| 3.5.3.5 | Function display | 43 |
| 3.5.3.6 | Level of assistance | 43 |
| 3.5.3.7 | Displayed speed | 44 |
| 3.5.4 | Operating elements | 44 |
| 4 | Technical data | 45 |
| 5 | Transportation, storage and assembly | 47 |
| 5.1 | Transportation | 47 |
| 5.1.1 | Transporting the battery | 49 |
| 5.1.2 | Using the transport securing system | 49 |
| 5.2 | Storing | 50 |
| 5.2.1 | Break in operation | 51 |
| 5.2.1.1 | Preparing a break in operation | 51 |
| 5.2.1.2 | Taking out of operation | 51 |
| 5.3 | Assembly | 52 |
| 5.3.1 | Required tools | 53 |
| 5.3.2 | Unpacking | 54 |
| 5.3.3 | Scope of delivery | 54 |
| 5.3.4 | Commissioning | 55 |
| 5.3.4.1 | Checking the battery | 57 |
| 5.3.5 | Mounting the wheel in the Suntour fork | 58 |
| 5.3.5.1 | Mounting the wheel with screw-on axle (15 mm) | 58 |
| 5.3.5.2 | Mounting the wheel with screw-on axle (20 mm) | 60 |
| 5.3.5.3 | Mounting the wheel with a quick release axle | 61 |

Table of contents

| | | |
|----------|---|-----------|
| 5.3.6 | Mounting the wheel with a quick release | 65 |
| 5.3.7 | Mounting the wheel in the FOX fork | 68 |
| 5.3.7.1 | Mounting the wheel with the quick release (15 mm) | 68 |
| 5.3.7.2 | Adjusting the FOX quick release | 69 |
| 5.3.7.3 | Mounting the wheel with Kabolt axles | 71 |
| 5.3.7.4 | Checking the stem and handlebars | 72 |
| 5.3.8 | Sale of the bicycle | 73 |
| 6 | Before the first ride | 74 |
| 6.1 | Adjusting the saddle | 74 |
| 6.1.1 | Adjusting the saddle tilt | 74 |
| 6.1.2 | Determining the seat height | 75 |
| 6.1.3 | Adjusting the seat height with quick release | 76 |
| 6.1.4 | Setting the height-adjustable seat post | 78 |
| 6.1.4.1 | Lowering the saddle | 78 |
| 6.1.4.2 | Raising the saddle | 78 |
| 6.1.5 | Adjusting the seat position | 79 |
| 6.2 | Adjusting the handlebars | 80 |
| 6.2.1 | Adjusting the height of the handlebars | 81 |
| 6.2.2 | Turning the handlebars to the side | 82 |
| 6.2.2.1 | Checking the clamping force of the quick releases | 83 |
| 6.2.2.2 | Adjusting the quick release clamping force | 83 |
| 6.3 | Adjusting the brake lever | 83 |
| 6.3.1 | Adjusting the pressure point on a Magura brake lever | 83 |
| 6.3.2 | Adjusting the grip distance | 85 |
| 6.3.2.1 | Adjusting the grip distance on a Magura brake lever | 86 |
| 6.4 | Adjusting the suspension of the Suntour fork | 87 |
| 6.4.1 | Adjusting the negative deflection | 88 |
| 6.4.1.1 | Adjusting the air suspension fork negative deflection | 88 |
| 6.4.1.2 | Adjusting the steel suspension fork negative deflection | 90 |
| 6.4.2 | Adjusting the rebound | 91 |
| 6.5 | Adjusting the suspension of the FOX fork | 92 |
| 6.5.1 | Adjusting the negative deflection | 92 |
| 6.5.2 | Adjusting the rebound | 95 |
| 6.6 | Adjusting the Suntour rear frame damper | 96 |
| 6.6.1 | Adjusting the negative deflection | 96 |
| 6.6.2 | Adjusting the rebound | 97 |
| 6.6.3 | Setting the compression | 98 |
| 6.7 | Adjusting the FOX rear frame damper | 99 |

Table of contents

| | | |
|----------|---|------------|
| 6.7.1 | Adjusting the negative deflection | 99 |
| 6.7.2 | Adjusting the rebound | 101 |
| 6.8 | Adjusting the drive system | 102 |
| 6.8.1 | Opening the settings menu | 102 |
| 6.8.1.1 | Clearing the settings | 103 |
| 6.8.1.2 | Setting the time | 104 |
| 6.8.1.3 | Setting Bluetooth LE | 105 |
| 6.8.1.4 | Bluetooth LE/ANT | 105 |
| 6.8.1.5 | Setting the light | 105 |
| 6.8.1.6 | Setting the brightness of the backlight | 106 |
| 6.8.1.7 | Setting the beep sound | 106 |
| 6.8.1.8 | Changing the units | 107 |
| 6.8.1.9 | Changing the language | 107 |
| 6.8.1.10 | Setting the gear shift | 108 |
| 6.8.1.11 | Resetting the rear derailleur | 108 |
| 6.8.1.12 | Closing the settings menu | 109 |
| 6.9 | Retracting the brake linings | 109 |
| 7 | Operation | 110 |
| 7.1 | Before each ride | 112 |
| 7.2 | Check list before each ride | 113 |
| 7.3 | Using the kickstand | 114 |
| 7.4 | Using the pannier rack | 115 |
| 7.5 | Rechargeable battery | 117 |
| 7.5.1 | Side down tube battery | 119 |
| 7.5.1.1 | Inserting the battery | 119 |
| 7.5.1.2 | Removing the battery | 121 |
| 7.5.2 | Charging the battery | 122 |
| 7.6 | Electric drive system | 125 |
| 7.6.1 | Switching on the drive system | 125 |
| 7.6.2 | Switching off the drive system | 126 |
| 7.7 | Display | 127 |
| 7.7.1 | Using the driving light | 127 |
| 7.7.2 | Using the push assist system | 127 |
| 7.7.3 | Selecting the level of assistance | 128 |
| 7.7.4 | Switching journey information | 129 |
| 7.7.4.1 | Clearing the displayed distance travelled | 129 |
| 7.8 | Gear shift | 131 |
| 7.8.1 | Selecting a higher gear manually | 131 |

Table of contents

| | | |
|----------|---|------------|
| 7.8.2 | Selecting a lower gear manually | 131 |
| 7.9 | Brake | 132 |
| 7.9.1 | Using the brake lever | 136 |
| 7.9.2 | Using the back-pedal brake | 136 |
| 7.10 | Suspension and damping | 137 |
| 7.10.1 | Adjusting the compression of the Suntour fork | 137 |
| 7.10.2 | Adjusting the compression of the Fox fork | 138 |
| 7.10.3 | Adjusting the compression of the Suntour damper | 139 |
| 7.10.4 | Adjusting the compression of the Fox damper | 140 |
| 8 | Maintenance | 142 |
| 8.1 | Cleaning and servicing | 144 |
| 8.1.1 | After each ride | 144 |
| 8.1.1.1 | Cleaning the suspension fork | 144 |
| 8.1.1.2 | Cleaning the rear frame damper | 144 |
| 8.1.1.3 | Cleaning the pedals | 144 |
| 8.1.2 | Basic cleaning | 145 |
| 8.1.2.1 | Cleaning the frame | 145 |
| 8.1.2.2 | Cleaning the stem | 146 |
| 8.1.2.3 | Cleaning the rear frame damper | 146 |
| 8.1.2.4 | Cleaning the wheel | 146 |
| 8.1.2.5 | Cleaning the drive elements | 146 |
| 8.1.2.6 | Cleaning the chain | 147 |
| 8.1.2.7 | Cleaning the battery | 147 |
| 8.1.2.8 | Cleaning the display | 148 |
| 8.1.2.9 | Cleaning the drive unit | 148 |
| 8.1.2.10 | Cleaning the brake | 149 |
| 8.1.3 | Servicing | 149 |
| 8.1.3.1 | Servicing the frame | 149 |
| 8.1.3.2 | Servicing the stem | 149 |
| 8.1.3.3 | Servicing the fork | 149 |
| 8.1.3.4 | Servicing the drive elements | 150 |
| 8.1.3.5 | Servicing the pedal | 150 |
| 8.1.3.6 | Servicing the chain | 150 |
| 8.1.3.7 | Servicing the drive elements | 150 |
| 8.2 | Maintenance | 151 |
| 8.2.1 | Wheel | 151 |
| 8.2.2 | Brake system | 152 |
| 8.2.3 | Electrical cables and brake cables | 152 |

Table of contents

| | | |
|-----------|---|------------|
| 8.2.4 | Gear shift | 152 |
| 8.2.5 | Stem | 153 |
| 8.2.6 | Checking the chain and belt tension | 153 |
| 8.2.7 | USB port | 154 |
| 8.2.8 | Suspension fork | 154 |
| 8.3 | Service | 155 |
| 8.4 | Adjusting and repairing | 157 |
| 8.4.1 | Use original parts and lubricants only | 157 |
| 8.4.2 | Axle with quick release | 158 |
| 8.4.2.1 | Checking the quick release | 159 |
| 8.4.3 | Adjusting the tyre pressure | 160 |
| 8.4.3.1 | Dunlop valve | 160 |
| 8.4.3.2 | Presta valve | 161 |
| 8.4.3.3 | Schrader valve | 162 |
| 8.4.4 | Reactivating the rear derailleur protection | 163 |
| 8.4.4.1 | Setting the gear shift | 164 |
| 8.4.5 | Offsetting the brake lining wear | 165 |
| 8.4.6 | Hydraulically operated rim brake | 165 |
| 8.4.7 | Hydraulically operated disc brake | 166 |
| 8.4.8 | Replacing the lighting | 166 |
| 8.4.9 | Setting the headlight | 166 |
| 8.4.10 | Repair by the specialist dealer | 166 |
| 8.4.11 | Replacing the lighting | 167 |
| 8.4.12 | Setting the headlight | 167 |
| 8.4.13 | Repair by the specialist dealer | 167 |
| 8.4.14 | First aid | 168 |
| 8.4.15 | The drive system or display do not start up | 169 |
| 8.4.15.1 | System messages | 170 |
| 8.4.15.2 | Special system messages | 170 |
| 8.5 | Accessories | 172 |
| 8.5.1 | Child seat | 172 |
| 8.5.2 | Bicycle trailer | 174 |
| 8.5.3 | Pannier rack | 175 |
| 9 | Recycling and disposal | 176 |
| 10 | Appendix | 178 |
| 10.1 | Battery error message | 178 |



Table of contents

| | | |
|-----------|------------------------------|------------|
| 10.2 | Warning message | 179 |
| 10.3 | Error message screen | 179 |
| 10.4 | EC declaration of conformity | 181 |
| 10.5 | Parts list | 182 |
| 11 | Table of figures | 190 |
| 12 | List of tables | 193 |
| 13 | Index | 195 |

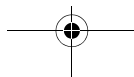
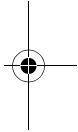

1 About these instructions

Read these operating instructions before commissioning the bicycle to ensure you use all the functions correctly and safely. The operating instructions are not a substitute for personal instruction by the supplying specialist dealer. The operating instructions are a component part of the bicycle. Therefore, if it is re-sold at a later time, they must be handed over to the subsequent owner.

These operating instructions are mainly intended for the rider and operator of the bicycle, who tend to be non-professionals.



Text passages which are expressly intended for specialist staff (e.g. bicycle mechanics) are clearly marked with a tool symbol.

Staff at all specialist dealers have specialist training and qualifications, and are therefore capable of identifying risks and preventing hazards which may arise during maintenance, servicing and repairs on the bicycle. Information for specialist staff does not require non-professionals to take any action.

1.1 Manufacturer

The manufacturer of the bicycle is:

ZEG Zweirad-Einkaufs-Genossenschaft eG
Longericher Straße 2
50739 Köln, Germany

Tel.: +49 221 17959 0
Fax: +49 221 17959 31
E-mail: info@zeg.de
Internet: www.zeg.de

About these instructions

1.2 Laws, standards and directives

These operating instructions comply with the essential requirements from:

- Machinery Directive 2006/42/EC,
- Electromagnetic Compatibility Directive 2014/30/EU,
- EN ISO 12100:2010 Safety of machinery – General principles of design – Risk assessment and reduction,
- EN 15194:2015, Cycles – Electrically power assisted cycles – EPAC bicycles,
- EN ISO 4210, Cycles – Safety requirements for bicycles,
- EN 11243:2016, Cycles – Luggage carriers for bicycles – Requirements and test methods,
- EN 82079-1:2012, Preparation of instructions for use – Structuring, content and presentation – Part 1: General principles and detailed requirements and
- EN ISO 17100:2016-05, Translation Services – Requirements for translation service.

1.3 Other valid documents

These operating instructions are only complete in conjunction with the other valid documents.

The following document applies for this product:

- Charger operating instructions.

No other information is also applicable.

The constantly updated lists of approved accessories and parts are available to specialist dealers.



About these instructions

1.4 Subject to change

The information contained in these operating instructions are the approved technical specifications at the time of printing. Any significant changes are included in a new issue of the operating instructions.

You will find any modifications to these operating instructions at:
www.bulls.de/service/downloads

1.5 Language

The original operating instructions are written in German. A translation is not valid without the original operating instructions.

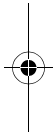

About these instructions

1.6 For your safety

The safety concept of the bicycle comprises four elements:

- rider and/or operator instruction, and bicycle maintenance and repair by the specialist dealer,
- the chapter on general safety,
- the warnings in these instructions and
- the safety marking on the type plates.

1.6.1 Instruction, training and customer service

The supplying specialist dealer will provide customer service. Contact details can be found on the back page of these operating instructions and in the data sheet. If you are unable to contact your specialist dealer, you will find other specialist dealers at www.zeg.de.



The specialist dealer authorised to perform repairs and maintenance work receives regular training.

The rider or the operator of the bicycle will be instructed in person on the bicycle functions when the supplying specialist dealer hands over the bicycle, if not before. This instruction particularly covers the bicycle's electrical functions and correct use of the charger.

Each rider to whom this bicycle is provided must receive instruction on the bicycle's functions. The operating instructions must be submitted to each rider in printed form and must be acknowledged and adhered to.

1.6.2 Basic safety notes

These operating instructions have a chapter with general safety notes [[▷ Chapter 2, page 20](#)]. You can distinguish this chapter as it has a grey background.

1.6.3 Warnings

Hazardous situations and actions are marked with warnings. The warnings in these operating instructions are shown as follows:





| SIGNAL WORD | Type and source of the danger |
|---|--|
| | Description of the danger and the consequences. |
| | ► Measures |
| | The following pictograms and signal words are used in the operating instructions for warnings and information notices: |
|  | Will lead to serious or even fatal injuries if ignored. High-risk hazard. |
|  | May lead to serious or even fatal injuries if ignored. Medium-risk hazard. |
|  | May lead to minor or moderate injuries. Low-risk hazard. |
|  | May lead to material damage if ignored. |

Table 1: Meanings of the signal words

About these instructions

1.6.4

Safety markings

The following safety markings are used on the bicycle's type plates:



General warning



Adhere to the instructions for use

Table 2:

Safety markings on the product

1.7

For your information

1.7.1

Instructions for actions

Instructions for actions are structured in accordance with the following pattern:

- ✓ Requirements (optional)
- ▶ Instruction for action
- ⇒ Result of the action (optional)

About these instructions

1.7.2

Information on the type plate

Alongside the warnings, the type plates of the products also contain other important information on the bicycle:





| | | |
|---|----------|--|
|  | 1 | only suitable for the road, no off-road riding or jumps |
|  | 2 | suitable for roads, off-road riding and jumps of up to 15 cm |
|  | 3 | suitable for rough off-road riding and jumps of up to 61 cm |
|  | 4 | suitable for rough off-road riding and jumps of up to 122 cm |
|  | 5 | suitable for the most difficult terrain |

Table 3:

Area of use







| | |
|---|--|
|  | City and trekking bicycle |
|  | Child's bicycle / bicycle for young adults |
|  | BMX bicycle |
|  | Mountain bike |
|  | Racing bicycle |
|  | Carrier bicycle |
|  | Folding bicycle |

Table 4:

Bicycle type

About these instructions



Read the instructions



Separate collection of electrical and electronic devices



Separate collection of batteries



Device of protection class II



Only suitable for use indoors



Fuse (device fuse)



EU conformity

Table 5:

Information on the type plate

1.7.3

Language conventions

The bicycle described in these operating instructions may be equipped with alternative components. The equipment of the bicycle is defined by the respective type number [▷ *Table 3, page 15*]. If applicable, the notes *alternative equipment* and *alternative version* make reference to the use of alternative components.

Alternative equipment describes additional components which are not necessarily an integral part of every bicycle in these instructions.

Alternative version explains the various variants of components if they differ in use.

About these instructions

The following terms are used for better legibility:

| Term | Meaning |
|------------------------|---|
| Operating instructions | Original operating instructions or translation of the original operating instructions |
| Bicycle Motor | Electric motor driven cycle Drive motor |

Table 6:

Simplified terms

The following conventions are used in these operating instructions:

| Convention | Use |
|-------------------------------------|---|
| <i>Italics</i> | Entry in the index |
| SPACED | Indicators on the <i>display screen</i> |
| [> <i>Example, page numbering</i>] | Cross references |
| • | Bulleted lists |

Table 7:

Conventions

About these instructions

1.8 Type plate

The type plate is situated on the *frame*. The type plate features the following information:

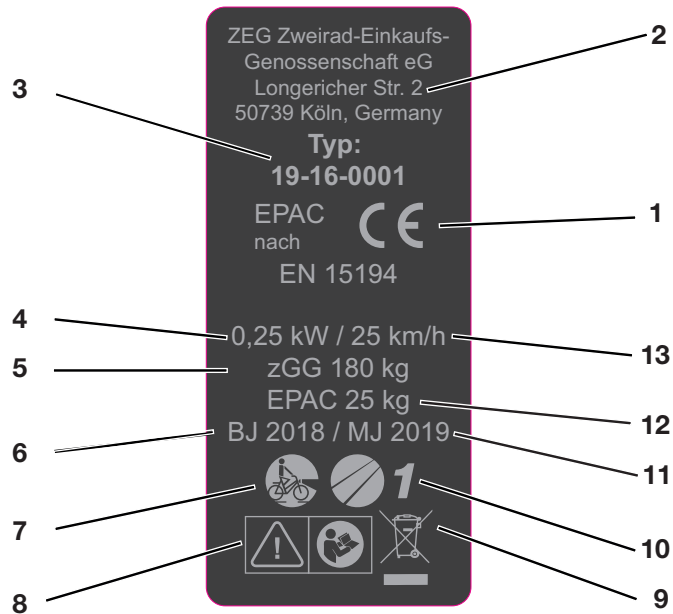

Figure 1:

Type plate, example

- 1 CE marking
- 2 Manufacturer
- 3 Type number
- 4 Nominal continuous power
- 5 Permitted total weight
- 6 Year of manufacture
- 7 *Bicycle type*
- 8 *Safety instructions*
- 9 *Disposal instruction*
- 10 *Area of use*
- 11 Model year
- 12 Weight of the ready-to-ride bicycle
- 13 Shut-off speed

1.9 Identifying

1.9.1 Operating instructions

The identification number of these operating instructions is made up of the document number, the version number and the release date. It can be found on the cover page and in the footer.

| | |
|------------------------------|--------------------------|
| Identification number | 034-03224_1.0_11.12.2018 |
|------------------------------|--------------------------|

Table 8:

Identification number of the operating instructions

1.9.2 Bicycle

These BULLS operating instructions refer to the *model year* 2019. The production period is from August 2018 to July 2019. They are issued in August 2018.

The operating instructions are a component part of the following bicycles:

| <i>Type number</i> | <i>Model</i> | <i>Bicycle type</i> |
|--------------------|---------------------------|---------------------|
| 19-18-4022 | E-Core Evo AM RS Di2 27.5 | Mountain bike |
| 19-18-4027 | E-Core Evo Di2 27.5+ | Mountain bike |
| 19-18-4028 | E-Core Evo Di2 29 | Mountain bike |
| 19-18-4023 | E-Core Evo AM Di2 | Mountain bike |
| 19-19-4001 | E-Core Evo EN Di2 | Mountain bike |
| 19-18-4025 | E-Core Evo 2 27.5+ | Mountain bike |
| 19-18-4024 | E-Core Evo TR2 | Mountain bike |
| 19-18-4028 | E-Core Evo 2 29 | Mountain bike |

Safety

2

Safety

2.1

Requirements for the rider

If there are no legal requirements for riders of electrically power-assisted cycles, we recommend that the rider should be a minimum 15 years of age and have experience with muscle-powered bicycles.

The physical and mental abilities of the rider must be sufficient for the use of a muscle-powered bicycle.

2.2

Hazards for vulnerable groups

The battery and the charger must be kept out of the reach of children.

If the bicycle is used by minors, comprehensive instruction should be provided by or in the presence of the legal guardians. Supervised use should also be scheduled until it is certain that the bicycle is being used as per these operating instructions. Legal guardians hold sole responsibility for determining whether minors are capable of using the bicycle.

2.3

Personal protective equipment

We recommend that you wear a suitable safety helmet. We also recommend that you wear typical, long, close-fitting cycling clothing and sturdy footwear.

2.4

Proper use

The bicycle may only be used in a perfect, fully functional condition. National requirements may apply to the bicycle which differ from the standard equipment. For riding on public roads, some special regulations apply in relation to the *driving light*, *reflectors* and other components.

The general laws and the regulations for the prevention of accidents and environmental protection in the respective country of use must be adhered to. All check lists and instructions for actions in these operating instructions must be met. Approved accessories can be installed by specialist staff.

Each bicycle is assigned a *bicycle type*, which determines its proper use and area of usage.

2.4.1



Mountain bike

The mountain bike is designed for sporting use. The design characteristics include a short wheelbase, a sitting position with the rider inclined towards the front, and a brake requiring low actuation force.

A mountain bike is a piece of sporting equipment. It requires an adaptation period as well as physical fitness. Use requires the appropriate training; in particular riding in bends and braking should be practised.

The strain on the rider, in particular the hands and wrists, arms, shoulders, neck and back, is accordingly high. Inexperienced riders tend to brake excessively and lose control as a result.

Safety



2.5

Area of use:

Suitable for tarmacked roads, cycle paths and easy to demanding off-road riding, sections with moderate slopes and jumps up to 61 cm.

Suitable for tarmacked roads, cycle paths and easy to demanding off-road riding, limited downhill use and jumps up to 122 cm.

Suitable for tarmacked roads, cycle paths and easy to extremely difficult off-road riding, unlimited downhill use and any jumps

Improper use

Failure to adhere to the proper use poses a risk of personal injury and material damage. The bicycle is not suitable for the following uses:

- when the electrical drive system has been manipulated
- riding with a damaged or incomplete bicycle
- riding over steps
- riding through deep water
- lending the bicycle to untrained riders
- carrying other people
- riding with excessive luggage
- riding with no hands
- riding on ice and snow
- improper servicing
- improper repair
- tough areas of use, such as professional competitions
- stunt riding or acrobatics.

2.5.1**Mountain bike**

A mountain bike must be retrofitted with lighting, a guard etc. according to the applicable national laws and regulations before it can be used in public street traffic.

Forbidden areas of use:



Never ride downhill or perform jumps over 61 cm.



Never traverse extremely difficult off-road terrain or perform jumps over 122 cm.



Never exceed your personal limits.

2.6**Duty to take care**

The safety of the bicycle can only be assured if all the necessary measures are taken.

2.6.1**Operator**

The operator has the duty of care and responsibility for scheduling these measures and checking that they are implemented.

The operator:

- makes these operating instructions available to the rider for the duration of use of the bicycle. If necessary, they translate the operating instructions into a language which the rider understands.
- familiarises the rider with the functions of the bicycle before the first ride. Only riders who have received instruction may be allowed to ride.
- instructs the rider on proper use and the wearing of personal protective equipment.
- only employs specialist staff for maintenance and repair of the bicycle.

Safety

The printed EC Declaration of Conformity in the appendix is valid providing that the bicycle remains unchanged from its original condition. As soon as the user makes any relevant modifications or additions, they legally become the manufacturer. He must independently guarantee compliance with the EC directives again in order to:

- circulate the bicycle again,
- apply the CE marking and
- avoid compromising occupational safety.

2.6.2

Rider

The rider:

- receives instruction before the first ride. They can clarify any questions relating to the operating instructions with the operator or specialist dealer
- wears personal protective equipment.
- assumes all the obligations of the operator in case the bicycle changes hands.

3 Description

3.1 Overview

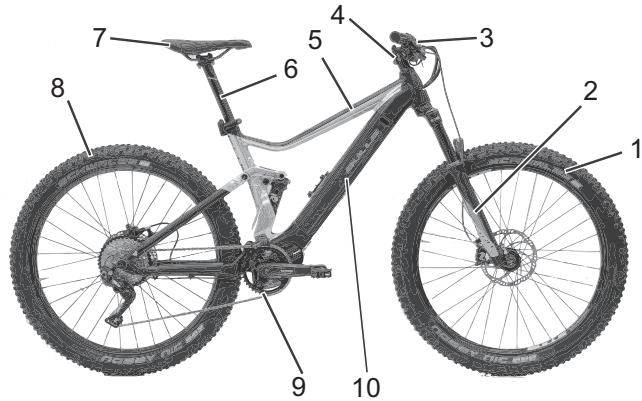

Figure2:

Bicycle viewed from the right, E Core Evo TR2 used as example

- 1 *Front wheel*
- 2 *Fork*
- 3 *Handlebars*
- 4 *Stem*
- 5 *Frame*
- 6 *Seat post*
- 7 *Saddle*
- 8 *Rear wheel*
- 9 *Chain*
- 10 *Battery, frame number and type plate*

Description

3.2 Handlebars

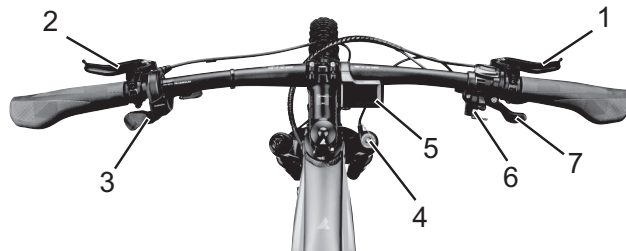

Figure 3: Detailed view of bicycle from rider position, example

- 1 Rear brake lever
- 2 Front brake lever
- 3 Control panel
- 4 Fork lock on suspension fork head
- 5 *Shifter*

3.3 Wheel and fork

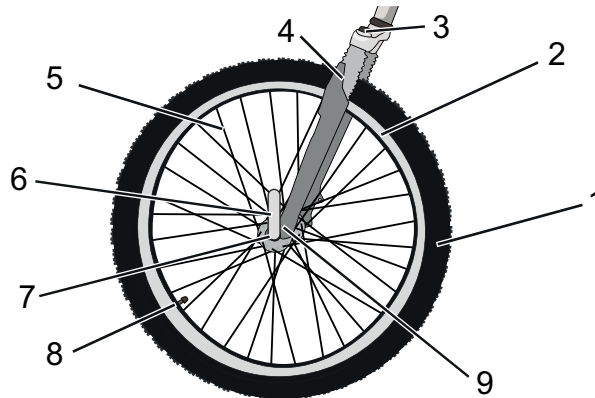

Figure 4: Components of the wheel – example showing front wheel

- | | |
|---|---|
| 1 | Tyre |
| 2 | Rim |
| 3 | Suspension fork head with setting wheel |
| 4 | Fork |
| 5 | Spoke |
| 6 | Quick release |
| 7 | Hub |
| 8 | Valve |
| 9 | Fork end of the suspension fork |

3.3.1 Valve

Each wheel has a valve. It is used to fill the *tyre* with air. There is a valve cap on each valve. The screw-on valve cap keeps out dust and dirt.

The bicycle either has a classical *Dunlop valve*, a *Presta valve* or a *Schrader valve*.

Description

Dunlop valve



The rider can easily exchange the valve and quickly release the air. The air pressure cannot be measured with this valve.

Presta valve



The Presta valve requires a smaller hole in the rim, which is why it is especially suitable for the narrow rims of racing bicycles. The air pressure can be measured with this valve.

Schrader valve



The rider can fill the Schrader valve very easily at a petrol station. The air pressure can be measured with this valve.

3.3.2 Suspension

Both forks and suspension forks are fitted in this model series. A suspension fork is based either on a steel spring or air suspension. Unlike a rigid fork, a suspension fork has two functions which improve floor contact and comfort: suspension and damping.

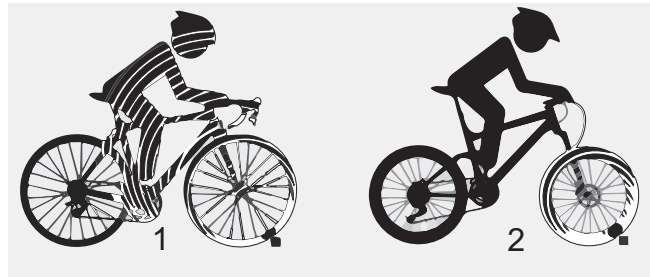

Figure 5: Bicycle without suspension (1) and with suspension (2) when riding over an obstacle

The suspension prevents an impact, such as one caused by a stone lying in the bike's path, from being channelled directly into the rider's body via the fork. The impact is absorbed by the suspension system instead. This causes the suspension fork to compress. The compression can be disabled so that a suspension fork reacts like a rigid fork. The switch to disable the fork is called a remote lockout.

After compressing, the suspension fork returns to its original position. If there is a damper, it decelerates movement, preventing the suspension system from springing back in an uncontrolled manner and stopping the fork from vibrating up and down.

Description

Dampers which dampen compressive deflection movements, i.e. a compression load, are called compression dampers or compression dashpots.

Dampers which dampen rebound deflection movements, i.e. a rebound load, are called rebound dampers or dashpots.

3.3.3

Suspension fork structure

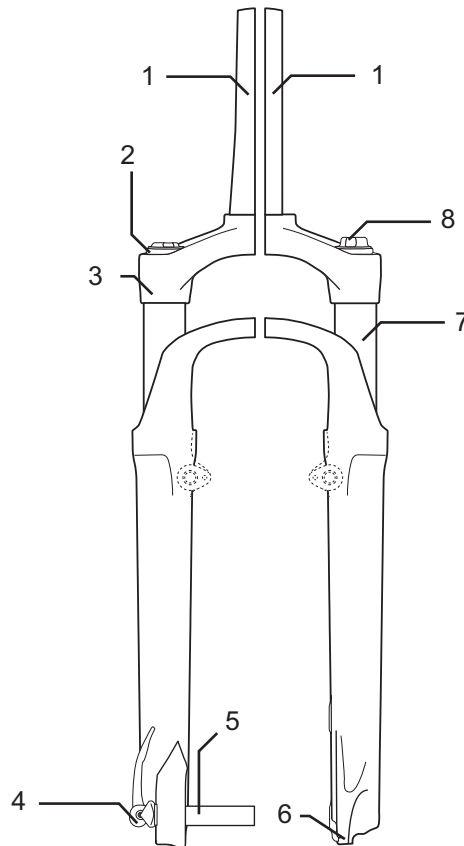

Figure 6:

Example showing Suntour fork: The stem and handlebars are fastened to the fork shaft (1). The wheel is fastened to the quick release axle (6). Other elements: The compression setting (2), crown (3), Q-Loc (5), dust seal (6), fork end for quick release (7), stanchion (8) and spring (9)

3.3.3.1

Air suspension fork structure

The fork of the bicycle features both air suspension and a compression damper, in addition to a rebound damper in some cases.

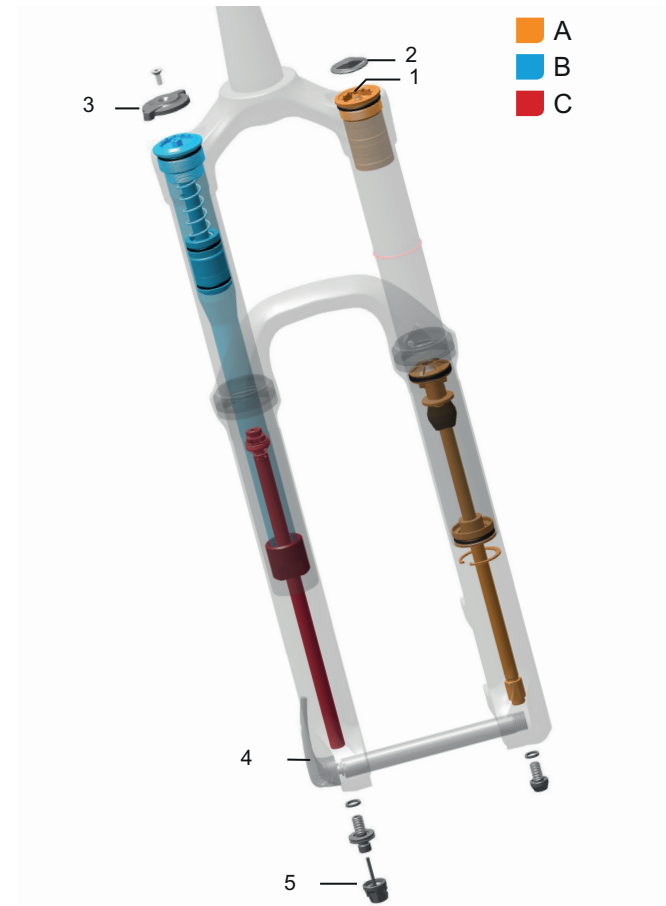

Figure 7:

Example showing a Yari fork – diagram with the operating elements: Air valve (1), valve cap (2) fork lock (3), quick release (4) and rebound damper adjuster (5) and the assembly groups: Air suspension fork (A), compression damper assembly group (B) and rebound damper assembly group (C)

Description

3.3.3.2

Structure of the FOX rear frame damper

The rear frame damper features air suspension, a compression damper and a rebound damper.

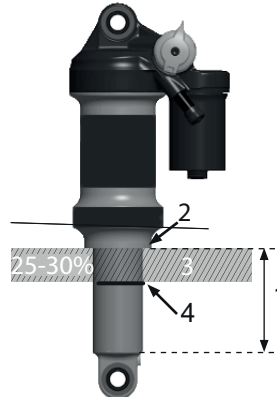

Figure 8:

Example showing FOX rear frame damper

- 1 Guide rod eye
- 2 Air valve
- 3 Setting wheel
- 4 Lever
- 5 Air chamber
- 6 O-ring

3.3.3.3**Structure of the Suntour rear frame damper**

The rear frame damper features air suspension, a compression damper and a rebound damper.

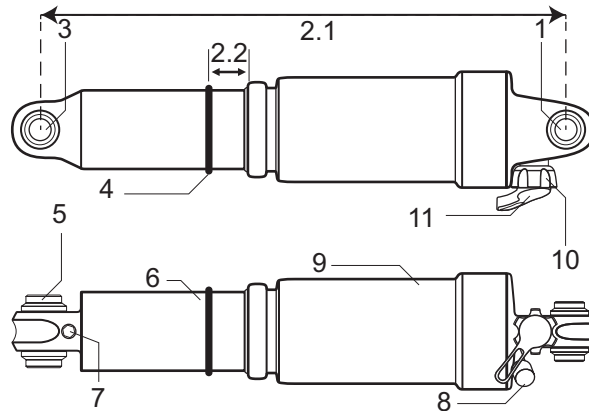
**Figure 9:****Example showing Suntour rear frame damper**

- 1 Upper eye
- 2.1 Total damper length
- 2.2 SAG
- 3 Lower eye
- 4 O-ring
- 5 Sleeve
- 6 Damper unit
- 7 IFP (internal floating piston)
- 8 Air valve
- 9 Air chamber
- 10 Lockout lever
- 11 Rebound lever

Description

3.4 Brake system

The bicycle's brake system comprises a hydraulic rim brake on both the front and rear wheel.

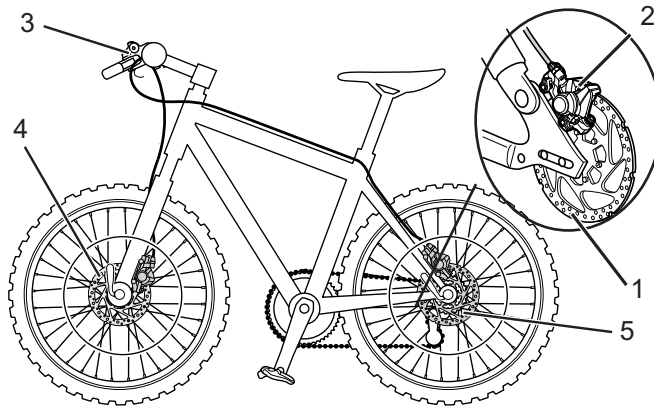

Figure 10: Bicycle brake system with a disc brake, example

- 1 Brake disc
- 2 Brake calliper with brake linings
- 3 *Handlebars with brake levers*
- 4 Front wheel brake disc
- 5 Rear wheel brake disc

On a bicycle with a disc brake, the brake disc is screwed permanently to the *hub* of the wheel.

The brake lever is pulled to increase brake pressure. The brake fluid is used to transfer pressure through the brake lines to the cylinders in the brake calliper. The braking force is boosted by a speed reduction and applied to the brake linings. These apply the brake disc mechanically. If the brake lever is pulled, the brake linings are pressed against the brake disc, and the movement of the wheel is decelerated until it comes to a stop.

About these instructions

3.5 Electric drive system

The bicycle is driven by muscle power via the chain drive. The force which is applied by pedalling in the direction of travel, drives the front chain wheel. The chain transmits the force onto the rear chain wheel and then onto the rear wheel.

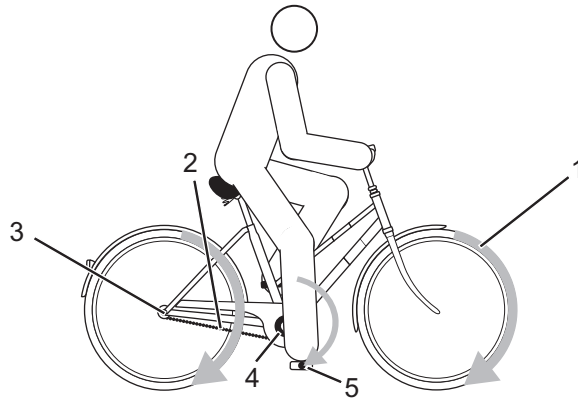

Figure 11:

Diagram of mechanical drive system

- 1 Direction of travel
- 2 Chain
- 3 Rear chain wheel
- 4 Front chain wheel
- 5 Pedal

The bicycle also has an integrated, electric drive system.

About these instructions

The electric drive system comprises the following components:

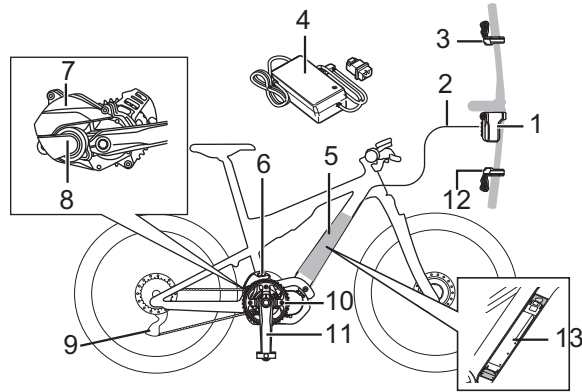

Figure 12:

Diagram of electric drive system

- 1 Display
- 2 Connection cable
- 3 Assistance lever
- 4 Charger
- 5 Battery
- 6 Chain tensioner
- 7 Drive unit cover
- 8 Drive unit
- 9 Rear derailleur (DI2)
- 10 Front chainring
- 11 Crank
- 12 Shifter
- 13 Battery

As soon as the required muscle power from the rider pedalling passes a certain level, the motor is activated gently and assists the pedalling motion of the rider. The motor force is determined by the set level of assistance.

The bicycle does not have a separate emergency stop or emergency shut-off button.

About these instructions

The motor switches off automatically as soon as the rider no longer pedals, the temperature is outside the permitted range, there is an overload or the shut-off speed of 25 km/h has been reached.

A push assist system can be activated. The push assist continues to drive the bicycle at walking speed as long as the rider pushes the **long assistance lever (left)** on the *handlebars*. The speed can be a maximum of 6 km/h in this case. The drive stops when the **long assistance lever** is released.

3.5.1 Rechargeable battery

The lithium ion battery has an internal electronic protection circuit. It is matched to the charger and the bicycle. The battery temperature is monitored at all times. The battery is protected against deep discharge, overcharging, overheating and short circuit. In the event of a hazard, a protective circuit switches the battery off automatically. The battery also switches to sleep mode for self-protection when not used for a longer period.

If the remaining battery capacity is low, the following systems are gradually switched off in the following order:

- 1. Pedal assistance (assistance mode automatically switches to [ECO], then assistance switches off.
- Assistance switches to [ECO] earlier if a battery-powered light is connected)
- 2. Gear shift
- 3. Light.

About these instructions

The battery's service life can be extended if it is well maintained and, above all, stored at the correct temperatures. The battery charge status will decrease with age, even if the battery is maintained properly. If the operating time is severely shortened after charging, this is a sign that battery has reached the end of its useful life.

| | |
|---|---------------|
| Transportation temperature | 5 °C - 25 °C |
| Ideal transportation temperature | 10 °C - 15 °C |
| Storage temperature | 5 °C - 25 °C |
| Ideal storage temperature | 10 °C - 15 °C |
| Charging ambient temperature | 10 °C - 30 °C |

Table 9:

Battery technical data

The bicycle has an integrated rechargeable battery:

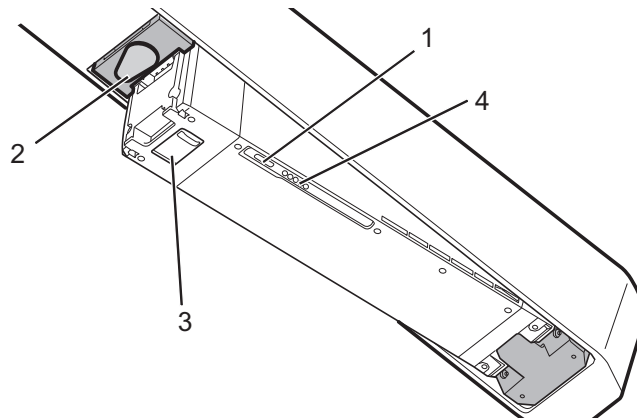

Figure 13:

Details of integrated battery, starting at bottom

- 1 On-Off button (battery)
- 2 Key cover
- 3 Charging port cover
- 4 Operating and charge status indicator

About these instructions

3.5.1.1

Battery charge status indicator

The five green LEDs on the battery charge status indicator show the battery charge status when the battery is switched on. Each LED represents 20% of the charge status.







| | |
|---|--|
|  | 100 - 81% |
|  | 80 - 61% |
|  | 60 - 41% |
|  | 40 - 21% |
|  | 20 - 1% |
|  | 0% when the battery is not fitted to the bicycle |
|  | 0% when the battery is fitted to the bicycle |

Table 10:

Battery charge status

The charge status of the switched-on battery is also shown on the *display*. If the battery charge status falls below 5%, all the LEDs on the battery charge status indicator will go out. However, the charge status is still shown on the *display*.

System errors and warnings are displayed by various lighting statuses on the *battery charge status* indicator. There is a table of system messages in the Appendix.

3.5.2

Driving light

When the driving light is activated, the *headlight* and the rear light are switched on together.

About these instructions

3.5.3 Display

The display controls the drive system with two operating elements shifter and assistance lever and displays the journey data. The *display* has a button.

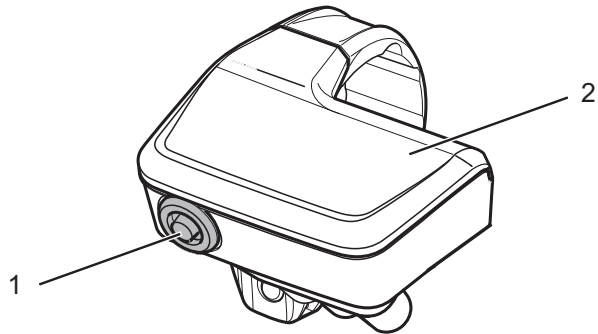

Figure 14: Overview of the display with button (1) screen (2)

The *display* has eight on-screen indicators:

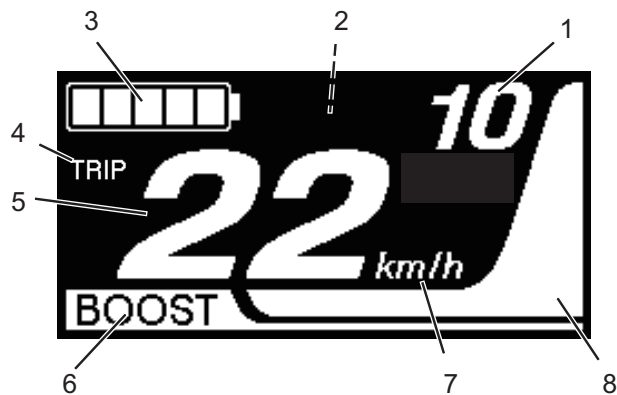

Figure 15: On-screen indicators overview

| Use | |
|-----|---------------------------------|
| 1 | Gear indicator |
| 2 | Display area of system messages |
| 3 | Battery charge status |

Table 11: On-screen indicators overview

About these instructions

| Use | |
|-----|---|
| 4 | Display of selected journey information |
| 5 | Function display |
| 6 | Level of assistance |
| 7 | Unit of measure for speed |
| 8 | Power |

Table 11:

3.5.3.1

On-screen indicators overview

Gear indicator

The rider has the choice between an automatic and manual gear shift. The selected gear shift type is displayed on the screen.

| Screen display | |
|----------------|---|
| AUTO | The electric drive system selects the ideal gear. |
| MANUAL | The rider selects the gears. |

Table 12:

3.5.3.2

Symbols of the gear recommendation function

System message

The drive system monitors itself continuously and if an error is detected, it is indicated by a system message. The drive system distinguishes between two system messages. Warning and error.

Types of warning



Figure 16:

Example: Warning W010

About these instructions

Warnings are displayed between the selected gear and the charge status indicator on the screen. There are limitations to the system's operation, depending on the error type. There is a table of system messages and remedial measures in the Appendix chapter.

Error messages



Figure 17:

Example: Error Message E010

Error messages are shown on the entire display. There are limitations to the drive system's operation, depending on the error type. There is a table of error messages and remedial measures in the Appendix chapter.

3.5.3.3

Battery charge status indicator

The battery charge status indicator indicates the current charge status as a percentage in a bar symbol.

| | |
|--|-----------|
| | 100 - 81% |
| | 80 - 61% |
| | 60 - 41% |
| | 40 - 21% |
| | 20 - 1% |
| | 0% |

Table 13:

Battery charge status

About these instructions

3.5.3.4 Journey information

The displayed journey information can be changed. The current selected journey information is displayed on the display screen. You can choose:

| Screen display | Function |
|----------------|---|
| DST | Distance travelled since the last reset |
| ODO | Display of the total distance travelled (cannot be changed) |
| RANGE* | Anticipated range of the available battery charge |
| TIME | Trip time |
| AVG | Average speed |
| MAX | Maximum achieved speed |
| CADENCE | Number of crank revolutions per minute |
| CLOCK | Clock |

Table 14: Journey information**3.5.3.5 Function display**

The values for the selected journey information are shown on the function display.

3.5.3.6 Level of assistance

The higher the level for assistance, the more the drive system assists the rider when pedalling. The following levels of assistance are available.

| Screen display | Details |
|----------------|--------------------------|
| BOOST | High level of assistance |
| TRAIL | Normal assistance |
| ECO | Low level of assistance |
| OFF | Assistance off |
| WALK | Activated push assist |

Table 15: Overview of levels of assistance

About these instructions

3.5.3.7 Displayed speed

A selection can be made in the system settings to determine whether the speed is displayed in kilometres per hour [km/h] or miles per hour [mph].

3.5.4 Operating elements

The electric drive system is operated using the display (II) and the left-hand control panel (I). The right-hand control panel (III) switches the gears.

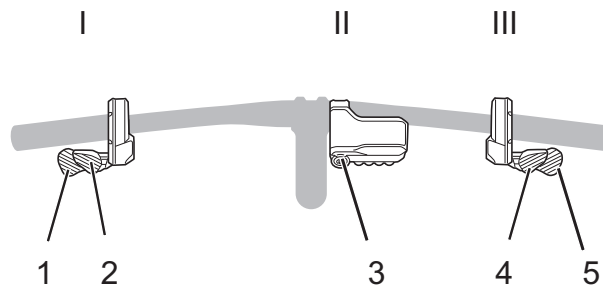

Figure 18:

Operating element overview

| | Designation |
|---|------------------------|
| 1 | Long assistance lever |
| 2 | Short assistance lever |
| 3 | Button |
| 4 | Long shifter |
| 5 | Short shifter |

Table 16:

Operating element overview

4 Technical data

Bicycle

| | |
|-------------------------------------|-----------------|
| Transportation temperature | -20 °C - +60 °C |
| Storage temperature | -20 °C - +60 °C |
| Operation temperature | -10 °C - 50 °C |
| Charging ambient temperature | 0 °C - 40 °C |
| Power output/system | 250 W (0.25 kW) |
| Shut-off speed | 25 km/h |

Table 17:

Bicycle technical data

Battery

| | |
|-------------------------------------|-----------------|
| Transportation temperature | -20 °C - +60 °C |
| Storage temperature | -20 °C - +60 °C |
| Charging ambient temperature | 0 °C - 40 °C |
| Charge voltage | 10 °C - 30 °C |
| Nominal voltage | 36 V DC |

Table 18:

Battery technical data

Emissions

| | |
|---|------------------------|
| A-weighted emission sound pressure level | < 70 dB(A) |
| Total vibration level for the hands and arms | < 2.5 m/s ² |
| Highest effective value of weighted acceleration for the entire body | < 0.5 m/s ² |

Table 19:

Emissions from the bicycle*

*The safety requirements as per Electromagnetic Compatibility Directive 2014/30/EU have been met. The bicycle and the charger can be used in residential areas without restriction.



Technical data



Tightening torque

| | |
|---|---------------|
| Axle nut tightening torque | 35 Nm - 40 Nm |
| Handlebars clamping screw maximum tightening torque* | 5 Nm - 7 Nm |

Table 20:

**Tightening torque values
*if there is no other data on the component**

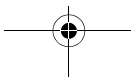
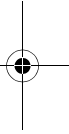
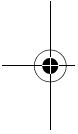

5 Transportation, storage and assembly

5.1 Transportation



Crash caused by unintentional activation

There is a risk of injury if the drive system is activated unintentionally.

- ▶ Remove the battery before the bicycle is transported.



Risk of fire and explosion due to high temperatures

Excessively high temperatures will damage the battery. Batteries may self-ignite and explode.

- ▶ Never expose batteries to sustained direct sunlight.



Oil leak if no transport securing device

The brake securing device prevents the brakes from being applied accidentally during transport. This could cause irreparable damage to the brake system or an oil leak, which will harm the environment.

- ▶ Never pull the brake lever when the wheel has been dismantled.
- ▶ Always use the transport securing system when transporting dismantled wheels.

NOTICE

If the bicycle is lying flat, oil and grease may leak from the bicycle.

If the shipping box with a bicycle is lying flat or on one end, it does not provide the *frame* and the wheels with adequate protection from damage.

- ▶ Only transport the bicycle in an upright position.

Transportation, storage and assembly

NOTICE

Bicycle rack systems which secure the bicycle standing on its head by the *handlebars* or *frame*, generate inadmissible forces on the components during transportation. This can cause the supporting parts to break.

- ▶ Never use bicycle rack systems which secure the bicycle standing on its head by the *handlebars* or *frame*.
- ▶ Take into account the ready-to-use bicycle's weight when transporting it.
- ▶ Remove the *display* and the batteries before transporting the bicycle.
- ▶ Protect the electrical components and connections on the bicycle from the elements with suitable protective covers.
- ▶ Remove accessories, for example drinking bottles, before transportation of the bicycle.
- ▶ When transporting by car, you must use a suitable bicycle rack system.



The specialist dealer will advise you on how to select a suitable rack system properly and how to use it safely.

- ▶ Transport the bicycle in a dry, clean place where it is protected from direct sunlight.



When shipping the bicycle, we recommend that you have the bicycle partially dismantled in the proper manner and packaged by the specialist dealer.

5.1.1 Transporting the battery

Batteries are subject to hazardous goods regulations. Undamaged batteries may be transported by private persons in road traffic. Commercial transport requires compliance with regulations concerning packaging, labelling and the transportation of hazardous goods. Open contacts must be covered and the battery securely packaged. The parcel service must be made aware of the presence of hazardous goods in the packaging.

5.1.2 Using the transport securing system

- ▶ Insert the transport securing devices between the brake linings.
- ⇒ The transport securing device is squeezed between the two linings.

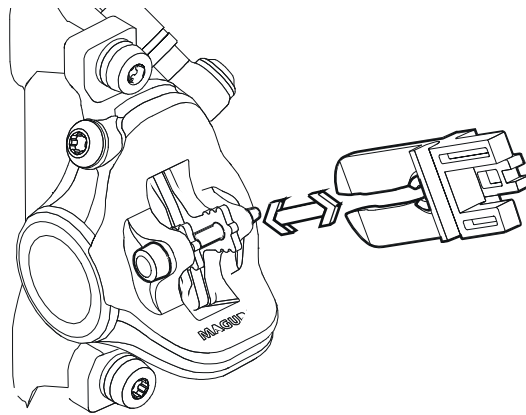

Figure 19: Fastening the transport securing device

Transportation, storage and assembly

5.2 Storing



Risk of fire and explosion due to high temperatures

Excessively high temperatures will damage batteries. Batteries may self-ignite and explode.

- ▶ Protect batteries against heat.
- ▶ Never expose batteries to sustained direct sunlight.



If the bicycle is lying flat, oil and grease may leak from the bicycle.

If the shipping box with a bicycle is lying flat or on one end, it does not provide the *frame* and the wheels with adequate protection from damage.

- ▶ Only store the bicycle in an upright position.
-
- ✓ If the bicycle features a hydraulic seat post, fix only the lower seat post or the frame into a fitting stand to prevent damage to the upper seat post and the seat post lever.
 - ✓ Never place a bicycle with a hydraulic seat post upside down on the floor; otherwise you, will damage the seat post lever.
 - ✓ Store the bicycle, battery and charger in a dry, clean location.

| | |
|----------------------------|--------------|
| Storage temperature | 5 °C - 25 °C |
|----------------------------|--------------|

| | |
|----------------------------------|---------------|
| Ideal storage temperature | 10 °C - 15 °C |
|----------------------------------|---------------|

Table 21:

Storage temperature for batteries, the bicycle and charger

Transportation, storage and assembly

5.2.1 Break in operation

NOTICE

The battery discharges when not in use. This can cause irreparable damage to the battery.

- ▶ The battery must be recharged every 8 weeks.

NOTICE

The battery may become damaged if it is connected permanently to the charger.

- ▶ Never connect the battery to the charger permanently.

If the bicycle is to be removed from service for longer than four weeks, e.g. in winter, a break in operation has to be prepared.

5.2.1.1 Preparing a break in operation

- ✓ Enable display storage mode.
- ✓ Remove the battery from the bicycle.
- ✓ Charge the battery to around 60% (three to four LEDs of the charge status indicator light up).
- ✓ The bicycle has to be cleaned with a damp cloth and preserved with wax spray. Never wax the friction surfaces of the brake.
- ✓ Before longer periods without use, it is recommendable to have your specialist dealer carry out servicing and basic cleaning and apply preservative agent.

5.2.1.2 Taking out of operation

- ▶ Store the bicycle, battery and charger in a dry, clean environment.
- ▶ Check the charge status of the battery after 8 weeks. If only one LED on the charge status indicator lights up, recharge the battery to around 60%.

Transportation, storage and assembly

5.3

Assembly



WARNING

Injury to the eyes

Problems may arise if the settings are not made properly and you may sustain serious injuries as a result.

- ▶ Always wear safety glasses to protect your eyes when carrying out maintenance work such as replacing components.



CAUTION

Crushing caused by unintentional activation

There is a risk of injury if the drive system is activated unintentionally.

- ▶ Remove the battery if the battery is not absolutely necessary for assembly.



- ✓ Assemble the bicycle in a clean and dry environment.
- ✓ The working environment temperature should be between 15 °C and 25 °C.

| | |
|--|---------------|
| Working environment temperature | 15 °C - 25 °C |
|--|---------------|

Table 22:

Working environment temperature

- ✓ If a fitting stand is used, it must be approved for a maximum weight of 30 kg.
- ✓ To reduce the weight, we recommend that you always disconnect the battery from the bicycle for the duration of use of the fitting stand.

Transportation, storage and assembly

5.3.1

Required tools

The following tools are required to assemble the bicycle:

- Knife
- Hexagon socket spanner 2 (2.5 mm, 3, mm 4 mm, 5 mm, 6 mm and 8 mm)
- Torque wrench with working range between 5 and 40 Nm
- Twelve-point square socket T-25
- Ring spanner (8 mm, 9 mm, 10 mm, 13 mm, 14 mm and 15 mm) and
- cross recess, flat head and ordinary screwdrivers.

The following tools are required for assembly, setting and maintenance purposes.

| Components | Area of use | Tool |
|-------------------------|--------------------------------------|---------------------|
| Display | Locking screw | 3 mm hex key |
| Control panel | Attachment screw for the unit | 3 mm hex key |
| | Lever locking screw | 2 mm hex key |
| Power cable | Plug connector | TL-EW02 |
| Battery mount | Lower mount housing | 5 mm hex key |
| | key cylinder | 2 mm hex key |
| | Key unit | 5 mm hex key |
| | Cover on key unit | Screwdriver no. 2 |
| | Upper mount housing | Screwdriver no. 2 |
| Speed sensor (SM-DUE10) | Speed sensor attachment screw | 4 mm hex key |
| Speed sensor (SM-DUE11) | Speed sensor attachment screw | Star bit [no.10] |
| Magnet unit | Attachment screw | Star bit [no.10] |
| Light cable | Attachment screw | Star bit [no. 2] |
| Drive unit | Drive unit attachment screw (M8) | – |
| | Cover attachment screw (M3) | Screwdriver [no. 2] |
| Front chainring | Retaining ring | TL-FC39+TL-FC36 |
| Crank | Cap | TL-FC16/TL-FC18 |
| | Locking plate | 5 mm hex key |
| Chain tensioner | Attachment screw for guide (M5) | 4 mm hex key |
| | Mounting plate attachment screw (M6) | 3 mm hex key |

Transportation, storage and assembly

5.3.2

Unpacking



CAUTION

Hand injuries caused by cardboard packaging

The shipping carton is closed with metal staples. There is a risk of puncture wounds and cuts when unpacking and crushing the packaging.

- ▶ Wear suitable hand protection.
- ▶ Remove the metal staples with pliers before the shipping carton is opened.

The packaging material consists mainly of cardboard and plastic film.

- ▶ The packaging has to be disposed of in accordance with the regulations of the authorities.

5.3.3

Scope of delivery

The bicycle was completely assembled in the factory for test purposes and then dismantled for transportation.

The bicycle is 95–98% pre-assembled. The scope of delivery includes:

- the pre-assembled bicycle
- the front wheel
- the pedals
- quick release (optional)
- the charger
- the operating instructions.

The battery is supplied separately from the bicycle.

Transportation, storage and assembly

5.3.4

Commissioning**CAUTION****Fire and explosion caused by incorrect charger**

Batteries which are charged with an unsuitable charger, may become internally damaged. This may result in fire or an explosion.

- ▶ Only ever use the battery with the supplied charger.
- ▶ Mark the supplied charger and these operating instructions clearly to prevent mix-ups – with the bicycle *frame number* or *type number*, for example.

**CAUTION****Burns from hot drive**

The drive cooler can become extremely hot during use. Contact may cause burns.

- ▶ Leave the drive unit to cool before cleaning.

Since initial commissioning of the bicycle requires special tools and specialist knowledge, only trained specialist staff may perform initial commissioning.

Experience has shown that a bicycle which has not yet been sold, is spontaneously handed to consumers as soon as it appears ready to ride.

- ▶ For this reason, every bicycle must be prepared, so that it is fully ready for use immediately after being assembled.
- ▶ Staff should work through the initial commissioning check list to prepare the bicycle, so that it is ready to ride.

Transportation, storage and assembly

Initial commissioning check list

- Check the battery
- The battery is supplied partially charged. Fully charge the battery to ensure full power
- Mount the wheels, quick release and pedals.
- Re-adjust the quick release clamping force if necessary.
- Thoroughly degrease the brake discs in disc brakes or the brake sides and linings in rim brakes with brake cleaner or spirit.
- Place handlebars, stem and saddle in the functional position and check they are firmly in place.
- Check all the components to make sure that they are firmly in place. Check all the settings and the tightening torque on the axle nuts.
- Check the entire cable harness to make sure that it is routed properly:
 - You must prevent the cable harness from coming into contact with moving parts.
 - The cable routes must be smooth and free from sharp edges.
 - Moving parts must not apply any pressure or tension to the cable harness.
- Check the drive system, the light equipment and the brakes to make sure that they are fully functional and effective.
- Adjust the headlight.
- Set the drive system has to the national language and the appropriate system of measurement.
- Check the software version of the drive system and update it as necessary.
- Take a test drive to check the brake system, gear shift and the electric drive system.

Transportation, storage and assembly

5.3.4.1

Checking the battery

**Risk of fire and explosion due to faulty battery**

The safety electronics on damaged or faulty batteries may fail. The residual voltage can cause a short circuit. The batteries may self-ignite and explode.

- ▶ Never charge a defective battery.

The battery needs to be checked before it is charged for the first time.

- ▶ Press the *On-Off button (battery)*.
- ⇒ If none of the LEDs on the operating and charge status indicator light up, the battery may be damaged.
- ⇒ The battery can be charged if at least one of the LEDs on the operating and charge status indicator is fully lit up, but not if all of them are.
- ▶ Once the battery has been charged, insert the battery on the bicycle.

Transportation, storage and assembly

5.3.5 Mounting the wheel in the Suntour fork *Alternative*

5.3.5.1 Mounting the wheel with screw-on axle (15 mm) *Alternative*

- ▶ Insert the axle completely on the drive side.

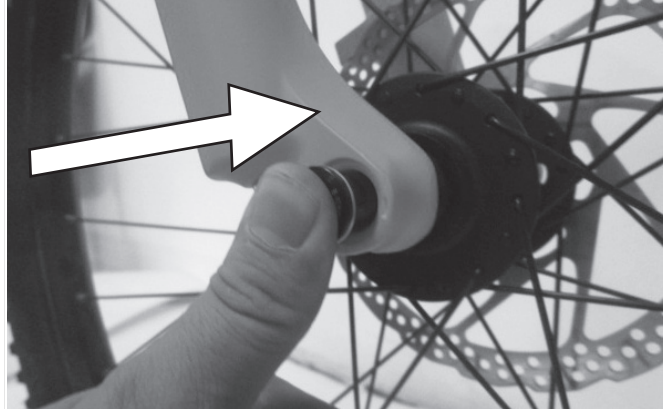

Figure 20: Fully inserting the axle

- ▶ Tighten the axle with a 5 mm hexagon socket spanner to 8–10 Nm.

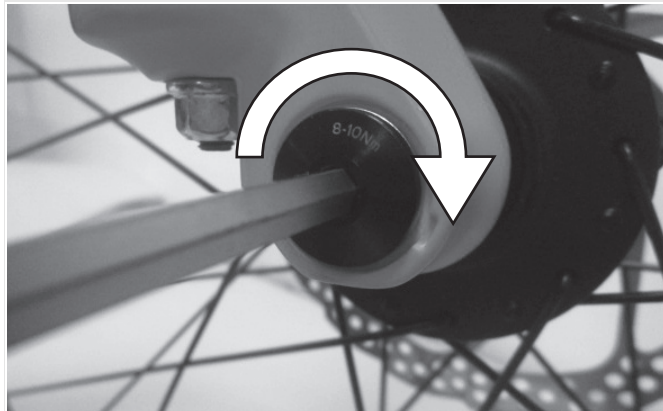

Figure 21: Tightening the axle

Transportation, storage and assembly

- ▶ Insert the securing screw on the non-drive side.

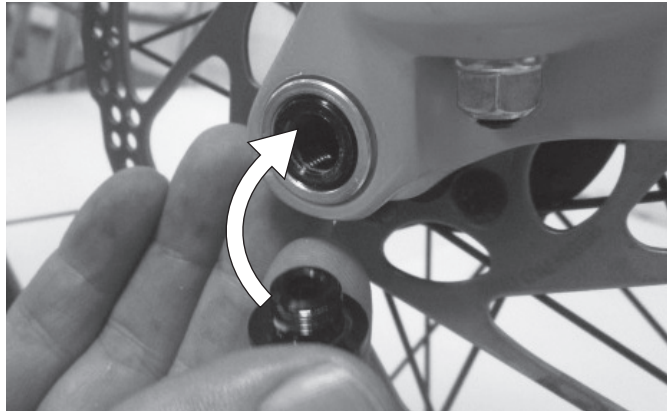

Figure 22:

Pushing the quick release lever into the axle

- ▶ Tighten the securing screw with a 5 mm hexagon socket spanner to 5–6 Nm.

⇒ The lever is mounted.



Figure 23:

Tightening the securing screw

Transportation, storage and assembly

5.3.5.2

Mounting the wheel with screw-on axle (20 mm) *Alternative*

- ▶ Insert the axle completely on the drive side.

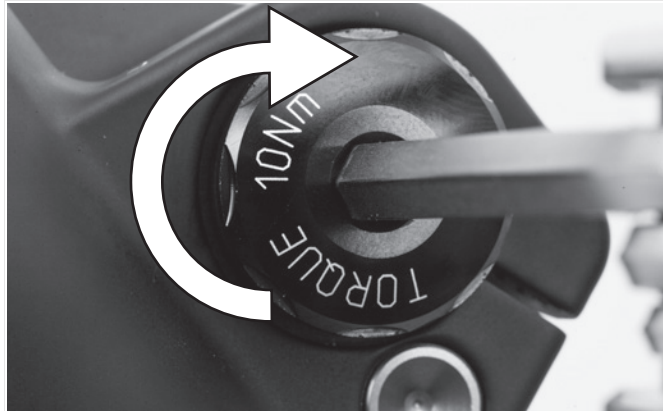

Figure 24:

Tightening the inserted axle

- ▶ Tighten the securing clip with a 4 mm hexagon socket spanner to 7 Nm.



Figure 25:

Tightening the axle

Transportation, storage and assembly

5.3.5.3

Mounting the wheel with a quick release axle**Alternative****Crash caused by loose quick release axle**

A faulty or incorrectly installed quick release axle may become caught in the brake disc and block the wheel. This will cause a crash.

- ▶ Never fit a defective quick release axle.

**Crash caused by faulty or incorrectly installed quick release axle**

The brake disc becomes very hot during operation. Parts of the quick release axle may become damaged as a result. The quick release axle becomes loose. This will result in a crash and injuries.

- ▶ The quick release axle and the brake disc must be opposite one another.

**Crash caused by incorrectly set quick release axle**

Insufficient clamping force will cause a detrimental transmission of force. The suspension fork or the quick release axle may break. This will result in a crash and injuries.

- ▶ Never fasten a quick release axle with a tool, such as a hammer or pliers.

Transportation, storage and assembly

- ▶ Insert the axle into the hub on the drive side.
Clamping version II.

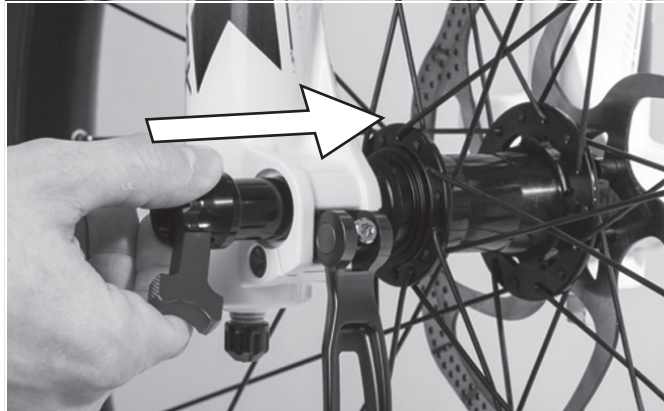

Figure 26: Pushing the axle into the hub

- ▶ Tighten the axle with the red handle.

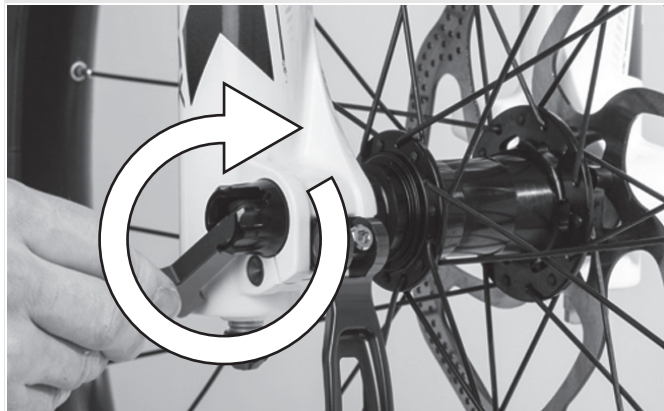

Figure 27: Tightening the axle

Transportation, storage and assembly

► Push the quick release lever into the axle.

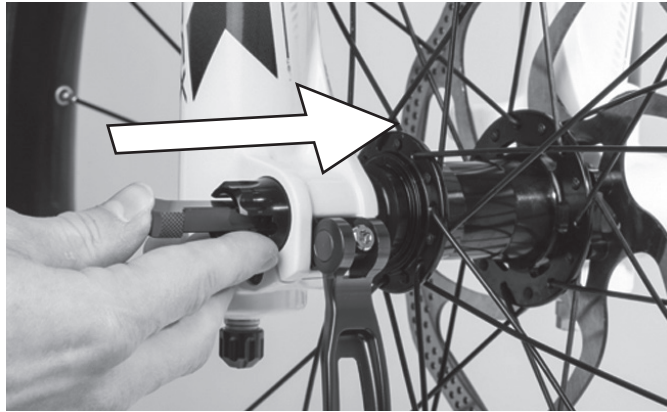

Figure 28:

Pushing the quick release lever into the axle

► Reverse the quick release lever.

⇒ The lever is secured.



Figure 29:

Securing the lever

Transportation, storage and assembly

- ▶ Check the position and clamping force of the quick release lever. The quick release lever must be flush with the lower housing. You must be able to see a slight impression on the palm of your hand when you close the quick release lever.



Figure 30:

Perfect position for the clamping lever

- ▶ Use a 4 mm hexagon socket spanner to adjust the clamping lever clamping force if required. Afterwards, check the quick release lever position and clamping force.

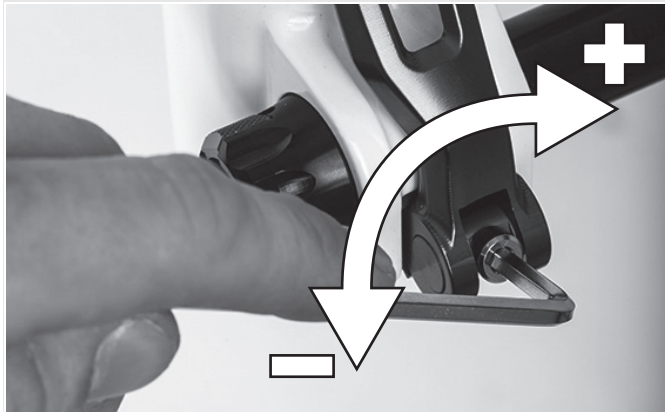

Figure 31:

Adjusting the quick release clamping force

Transportation, storage and assembly

5.3.6

Mounting the wheel with a quick release
Alternative**Crash caused by unfastened quick release**

A faulty or incorrectly installed quick release may become caught in the brake disc and block the wheel. This will cause a crash.

- ▶ Never fit a defective quick release.

**Crash caused by faulty or incorrectly installed quick release**

The brake disc becomes very hot during operation. Parts of the quick release may become damaged as a result. The quick release comes loose. This will result in a crash and injuries.

- ▶ The front wheel quick release lever and the brake disc must be situated on opposite sides.

**Crash caused by incorrectly set clamping force**

Excessively high clamping force will damage the quick release and cause it to lose its function.

Insufficient clamping force will cause a detrimental transmission of force. The suspension fork or the quick release may break. This will result in a crash and injuries.

- ▶ Never fasten a quick release using a tool (e.g. hammer or pliers).
- ▶ Only use the clamping lever with the specified set clamping force.

Transportation, storage and assembly

- ▶ Before mounting, ensure that the quick release flange is extended. Open the lever completely.

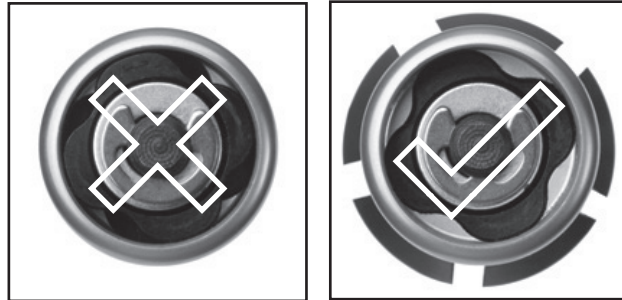

Figure 32:

Closed and opened flange

- ▶ Push in the quick release until you hear a clicking sound. Make sure that the flange is extended.

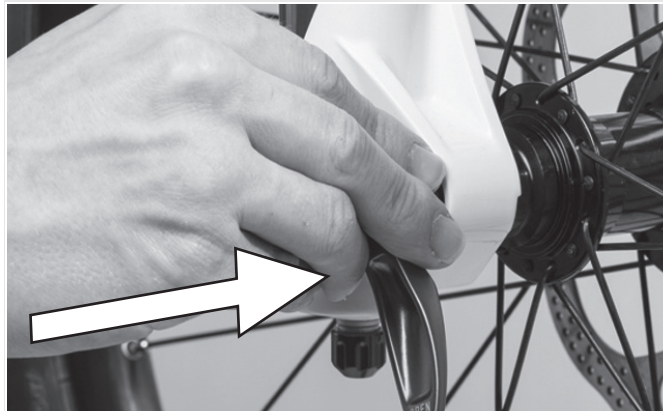

Figure 33:

Pushing the quick release in

Transportation, storage and assembly

- ▶ Adjust the clamping with a half-open clamping lever until the flange reaches the fork end.

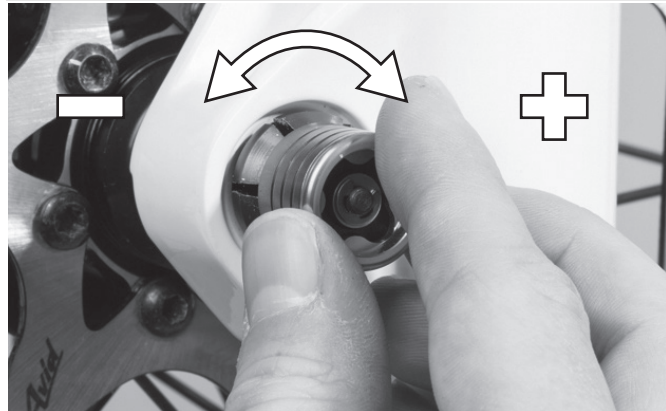

Figure 34:

Adjusting the clamping

- ▶ Fully close the quick release. Check the quick release to ensure it is firmly in place and adjust on the flange if necessary.

⇒ The lever is secured.



Figure 35:

Closing the quick release

Transportation, storage and assembly

5.3.7

Mounting the wheel in the FOX fork *Alternative*

5.3.7.1

Mounting the wheel with the quick release (15 mm) *Alternative*

The procedure for installing the 15 x 100 mm and 15 x 110 mm quick releases is the same.

- ▶ Place the front wheel in the fork ends of the fork. Push the axle through the fork end on the non-drive side and hub.

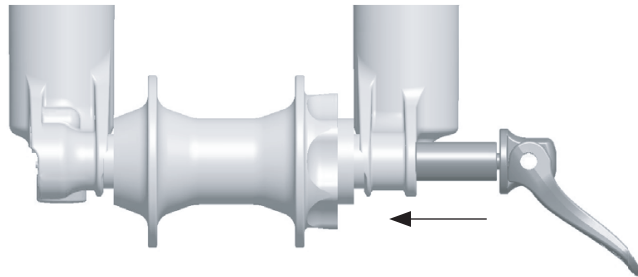

Figure 36:

Pushing the quick release in

- ▶ Open the axle lever.
- ▶ Turn the axle five to six complete revolutions clockwise into the axle nut.
- ▶ Close the quick release. The lever must be tensioned to the point that it leaves a mark on your hand.

Transportation, storage and assembly

► The lever must be 1 to 20 mm ahead of the fork leg in the closed position.

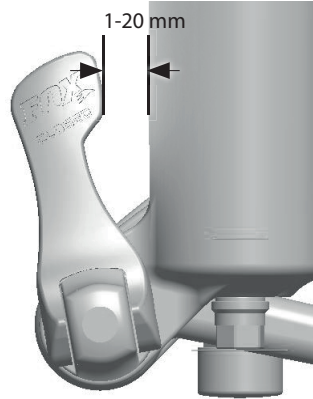

Figure 37:

Spacing between lever and fork leg

⇒ If the lever is tensioned too little or too much when closed in the recommended position (1 to 20 mm ahead of the fork), the quick release must be adjusted.

5.3.7.2

Adjusting the FOX quick release

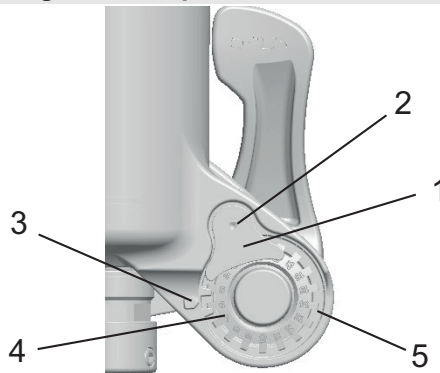

Figure 38:

Structure of quick release from rear with (1) axle nut lock, (2) axle nut securing screw, (3) directional arrow, (4) axle setting value and (5) axle nut

Transportation, storage and assembly

- ▶ Record the axle setting value (4) indicated by the directional arrow (3).
- ▶ Loosen the axle nut securing screw (2) with a 2.5 mm hex key by approx. four revolutions, but do not remove the screw completely.
- ▶ Turn the quick release lever to the open position and loosen the axle by approx. four revolutions.
- ▶ Press the axle inward from the side of the open lever. This pushes out the axle nut securing screw so that you can turn it out of the way.
- ▶ Push the axle further forward and turn the axle nut clockwise to increase the lever tension or anti-clockwise to reduce the lever tension.
- ▶ Reinsert the axle nut lock and tighten the screw to 0.9 Nm (8 in-lb).
- ▶ Repeat the steps for installing the axle to check proper installation and correct adjustment.

5.3.7.3**Mounting the wheel with Kabolt axles**
Alternative

The procedure for installing the 15 x 100 mm and 15 x 110 mm Kabolt axles is the same.

- ▶ Place the front wheel in the fork ends of the fork. Push the Kabolt axle through the fork end on the non-drive side and hub.

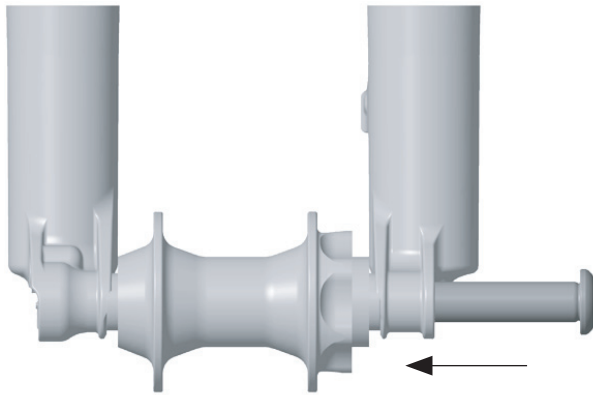
**Figure 39:****Pushing the Kabolt axle in**

- ▶ Tighten the Kabolt axle screw to 17 Nm (150 in-lb) with a 6 mm hex key.

Transportation, storage and assembly

5.3.7.4

Checking the stem and handlebars

Checking connections

- ▶ Stand in front of the bicycle to check whether the handlebars, stem and fork shaft are firmly attached to one another. Clamp the front wheel between your legs. Grasp the handlebar grips. Try to twist the handlebars towards the front wheel.

⇒ The stem must not move or twist.

Firm hold

- ▶ Place your entire body weight on the handlebars with the quick release lever closed to check that the stem is firmly in place.

⇒ The handlebars shaft must not move downwards in the fork shaft.

- ▶ If the handlebars shaft should move in the fork shaft, increase the quick release lever tensioning. To do so, turn the knurled nut slightly in a clockwise direction with the quick release lever open.

- ▶ Close the lever and check the stem is firmly in position.

Transportation, storage and assembly

Checking the headset backlash

- ▶ To check the handlebar headset backlash, close the quick release lever on the stem. Place the fingers of one hand on the upper headset cup, pull the front wheel brake with the other hand and try to push the bicycle backwards and forwards.
- ▶ The headset cup halves must not move towards one another while you are doing this. Note that there may be noticeable backlash due to worn-out bearing bushes or brake lining backlash in suspension forks and disc brakes.
- ▶ If there is headset backlash in the steering headset, you must adjust it as soon as possible; otherwise, the headset will become damaged. You must make the adjustment as described in the stem manual.

5.3.8

Sale of the bicycle

- ▶ Fill out the data sheet on the first page of the operating instructions.
- ▶ Adjust the bicycle to the rider.
- ▶ Set the *stand* and the *shifter*, and show the purchaser the settings.
- ▶ Instruct the operator or rider how to use all the functions of the bicycle.

Before the first ride

6 Before the first ride



Crash caused by incorrectly adjusted torques

If a screw is fastened too tightly, it may break. If a screw is not fastened enough, it may loosen. This will result in a crash and injuries.

- ▶ Always observe the indicated torques on the screw or in the operating instructions.
-

Only a correctly adjusted bicycle will guarantee you the desired ride comfort and health-promoting activity. Therefore adjust the *saddle*, the *handlebars* and the *suspension* to your body and your preferred riding style before the first ride.

6.1 Adjusting the saddle

6.1.1 Adjusting the saddle tilt

The saddle tilt must be adjusted to the seat height, the saddle and handlebar position, and the saddle shape to ensure an optimum fit. The seating position can be optimised in this way if needed. First, readjust the saddle after finding the handlebar position you prefer.

Before the first ride

- ⇒ Place the saddle tilt in the horizontal position to adjust the bicycle to your needs for the first time.

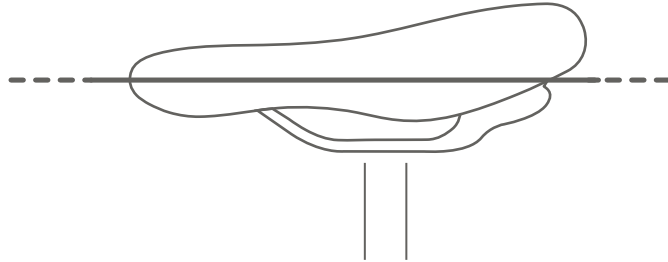

Figure 40: Horizontal saddle tilt

6.1.2

Determining the seat height

- ✓ To determine the seat height safely, either push the bicycle near to a wall, so that you can lean on the wall to support yourself or ask another person to hold the bicycle for you.
 - ▶ Climb onto the bicycle.
 - ▶ Place your heel on the pedal and extend your leg, so that the pedal is at the lowest crank rotation point.
- ⇒ The rider sits straight on the saddle if the seat is at an optimum height. If this is not the case, you can adjust the length of the seat post to your needs.

Before the first ride

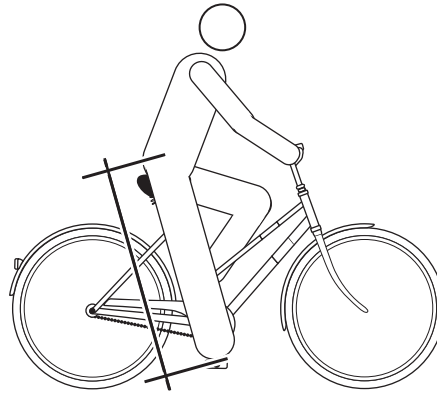

Figure 41: Optimal saddle height

6.1.3 Adjusting the seat height with quick release

- Open the quick release on the seat post to change the seat height. To do so, pull the clamping lever away from the seat post.

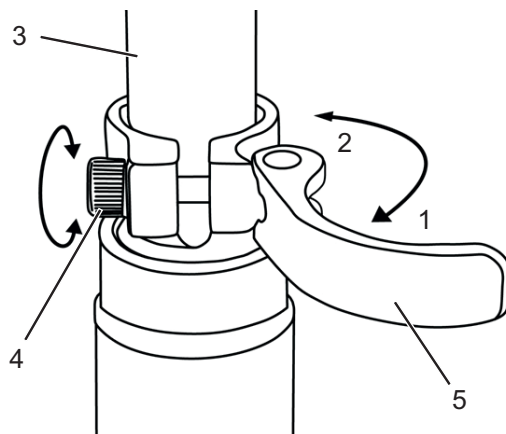

Figure 42: Seat post quick release (3) with clamping lever (5) and setting bolt (4) in the open position (1) and in the direction of the closed position (2)

Before the first ride

- ▶ Set the seat post at the required height.



Crash caused by an excessively high seat post setting

A *seat post* with is set too high will cause the *seat post* or the *frame* to break. This will result in a crash and injuries.

- ▶ Do not pull the seat post out of the frame beyond the minimum insertion depth marking.

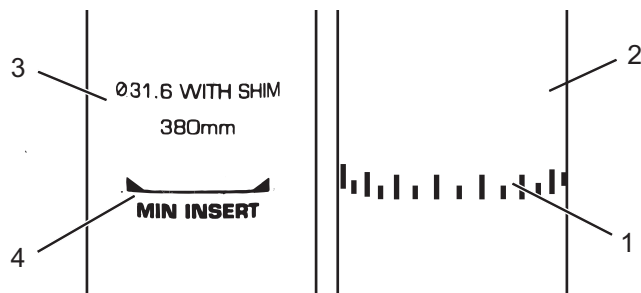

Figure 43:

Detailed view of the seat post – examples of the minimum insertion depth marking

- ▶ To close it, push the *seat post clamping lever* as far as it will go into the *seat post*.
- ▶ Check the *clamping force of the quick releases*.

Before the first ride

6.1.4 Setting the height-adjustable seat post

- ▶ When using your seat post for the first time, you must give it a firm push downwards to set it in motion. This is due to the natural tendency of the seal to repel oil from the seal surface. You only need to do this before the first use or after a longer period of non-use. Once you have displaced the post through its deflection, the oil spreads on the seal and the post begins to function normally.

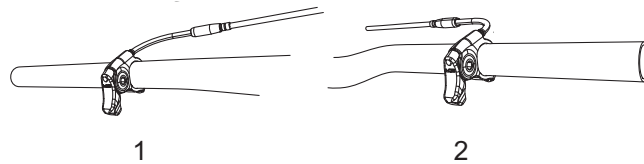

Figure 44: The seat post activation lever can be mounted either on the left (1) or the right (2) side of the handlebars

6.1.4.1 Lowering the saddle

- ✓ To lower the saddle, press your hand down on the saddle or sit on the saddle.
- ▶ Press the seat post activation lever and hold it down.
- ▶ Release the lever once you have reached the required height.

6.1.4.2 Raising the saddle

- ▶ Pull the seat post activation level.
- ▶ Remove any pressure on the saddle and release the lever once you have reached the required height.

6.1.5 Adjusting the seat position

The saddle can be shifted on the saddle frame. The right horizontal position ensures an optimal leverage position for legs. This prevents knee pain and painful incorrect pelvis positions. If you have displaced the saddle more than 10 mm, you then need to adjust the saddle height again since both settings affect one another.

- ✓ To adjust the seat position safely, either push the bicycle near to a wall, so that you can lean on the wall to support yourself or ask another person to hold the bicycle for you.
- ▶ Climb onto the bicycle.
- ▶ Place the pedals into the vertical position (3 o'clock position) with your feet.
- ⇒ The rider is sitting in the optimal sitting position if the knee cap perpendicular line runs through the pedal axle. If the perpendicular line crosses behind the pedal, bring the saddle forward. If the perpendicular line crosses in front of the pedal, bring the saddle back. Move the saddle within its permitted displacement range only (marked on the saddle stay).

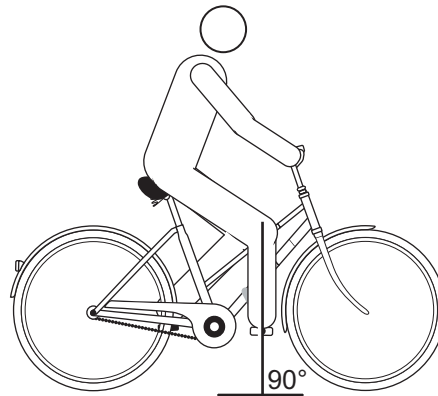

Figure 45: Knee cap perpendicular line

Before the first ride

6.2



Adjusting the handlebars

- ✓ The handlebars must only be adjusted while the bicycle is stationary.
- ▶ Unfasten and adjust the designated screw connections, and clamp them with the maximum tightening torque for the clamping screws of the handlebars.

Maximum tightening torque for the clamping screws of the handlebars*

5 Nm - 7 Nm

*if there is no other data on the component

Table 23:

Handlebars clamping screw maximum tightening torque

Adjusting the stem



Crash caused by loose stem

Incorrectly fastened screws may come loose due to impact. The stem may no longer be firmly fixed in its position as a result. This will result in a crash and injuries.

- ▶ Check the handlebars and the quick release system are firmly in position after the first two hours of riding.

Before the first ride

6.2.1 Adjusting the height of the handlebars



Crash caused by incorrectly set clamping force

Excessively high clamping force will damage the quick release and cause it to lose its function. Insufficient clamping force will cause a detrimental transmission of force. This can cause components to break. This will result in a crash and injuries.

- ▶ Never fasten a quick release using a tool (e.g. hammer or pliers).
 - ▶ Only use the clamping lever with the specified set clamping force.
-
- ▶ Open the clamping lever.
 - ▶ Pull the locking lever on the stem up, and simultaneously pivot the handlebars into the desired position.
- ⇒ You feel the locking lever click into place.
- ▶ Pull out the handlebars to the required height.
 - ▶ Lock the quick release.

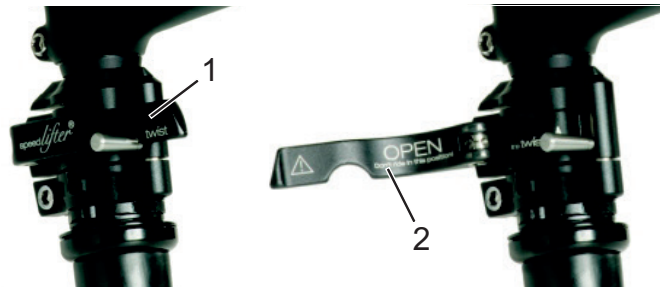

Figure 46:

Open (2) and closed (1) clamping lever on the stem; by.schulz speedlifter used as an example

Before the first ride

6.2.2 Turning the handlebars to the side *Alternative*



Crash caused by incorrectly set clamping force

Excessively high clamping force will damage the quick release and cause it to lose its function.

Insufficient clamping force will cause a detrimental transmission of force. This will result in a crash and injuries.

- ▶ Never fasten a quick release using a tool (e.g. hammer or pliers).
 - ▶ Only use the clamping lever with the specified set clamping force.
-
- ▶ Open the clamping lever.
 - ▶ Pull the locking lever on the stem up, and simultaneously pivot the handlebars into the desired position.
- ⇒ You feel the locking lever click into place.
- ▶ Pull out the handlebars to the required height.
 - ▶ Lock the quick release.
-

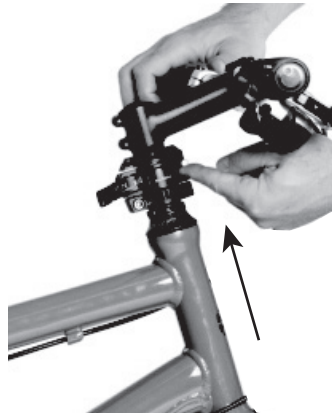

Figure 47:

Pulling locking lever upwards; by.schulz speedlifter used as an example

Before the first ride

6.2.2.1

Checking the clamping force of the quick releases

- ▶ Open and close the quick releases on the stem or the seat post.
- ⇒ The clamping force is sufficient if the clamping lever can be moved easily from the open final position into the middle and has to be pressed with the fingers or base of the thumb from the middle point onwards.

6.2.2.2

Adjusting the quick release clamping force

- ▶ If the *clamping lever on the handlebars* cannot be moved into its final position, screw out the *knurled nut*.
- ▶ Tighten the *knurled nut* on the seat post if the *clamping lever's* clamping force is not sufficient.



If you are unable to set the clamping force, the specialist dealer will need to check the quick release.

6.3

Adjusting the brake lever

6.3.1

Adjusting the pressure point on a Magura brake lever



Brake failure due to incorrect setting

If the pressure point is set with brakes where the brake lining and brake disc have reached their wear limit, the brakes may fail and cause an accident with injury.

- ▶ Before you set the pressure point, ensure that the brake lining and brake disc have not reached their wear limit.

Before the first ride

The pressure point setting is adjusted using the twist knob.

- ▶ Turn the twist knob towards the plus (+) symbol.
- ⇒ The brake lever moves closer to the handlebar grip.
Re-adjust the grip distance as necessary.
- ⇒ The lever pressure point activates sooner.

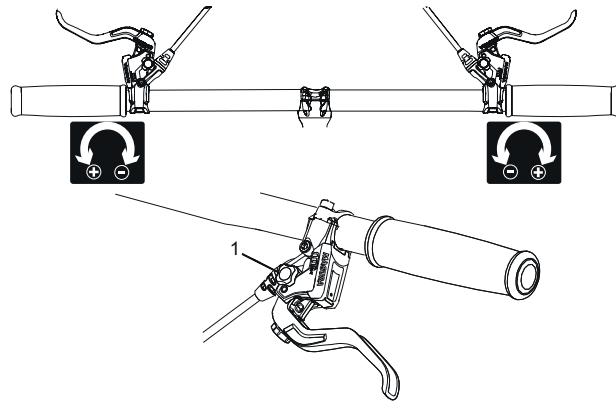

Figure 48:

Using the twist knob (1) to adjust the pressure point

Before the first ride

6.3.2 Adjusting the grip distance

! WARNING**Crash caused by incorrectly set grip distance**

If brake cylinders are set incorrectly or installed wrongly, the braking power may be lost at any time. This may cause you to fall from the bicycle and injure yourself.

- ▶ Once the grip distance has been set, check the position of the brake cylinder and adjust it as necessary.
- ▶ Never correct the brake cylinder position without special tools. Have a specialist dealer correct it.



The brake lever grip distance can be adjusted to ensure that it can be reached more easily. Contact your specialist dealer if the brake handle is too far from the handlebars or is hard to use.

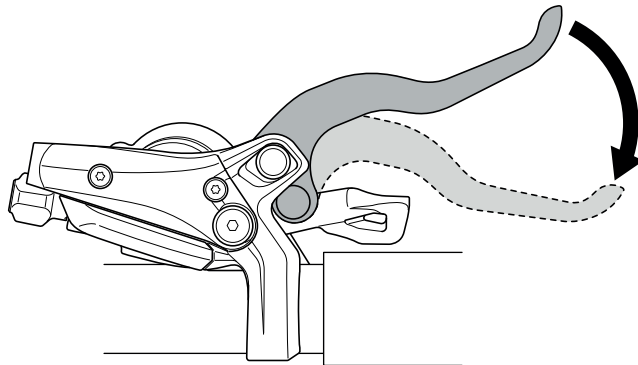

Figure 49: Brake lever grip distance

Before the first ride

6.3.2.1

Adjusting the grip distance on a Magura brake lever *Alternative*

Use a T25 TORX® wrench to turn the setting screw to adjust the grip distance.

- ▶ Turn the setting screw in the minus (–) direction.
⇒ The brake lever moves closer to the handlebar grip.
- ▶ Turn the setting screw in the plus (+) direction.
⇒ The brake lever moves away from the handlebar grip.

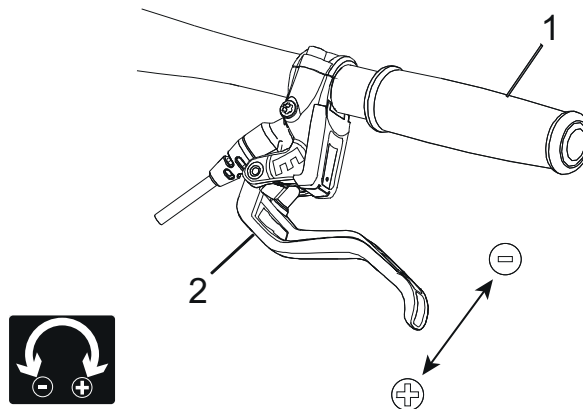

Figure 50:

Using the setting screw (2) to adjust the distance from the brake lever to the handlebar grip (1)

Before the first ride

6.4**Adjusting the suspension of the Suntour fork*****Alternative***

The following Suntour forks can be installed in this series of models:

| | |
|---------------|-----------------------|
| Aion-35 Boost | Air suspension fork |
| NCX | Air suspension fork |
| NEX | Steel suspension fork |
| XCM-ATB | Steel suspension fork |
| XCM | Steel suspension fork |
| XCR32 | Air suspension fork |
| XCR34 | Air suspension fork |

Table 24:**Overview of Suntour forks****Crash caused by incorrectly set suspension**

If the suspension is adjusted incorrectly, the fork may become damaged, so that problems may occur when steering. This will result in a crash and injuries.

- ▶ Never ride the bicycle without air in the air suspension fork.
- ▶ Never use the bicycle without adjusting the suspension fork to the rider's weight.
- ▶ Settings on the chassis change riding performance significantly. You need to get used to the bicycle and break it in to prevent accidents.



The adjustment shown here represents a basic setting. The rider should change the basic setting to suit the surface and his/her preferences.

Before the first ride

- It is advisable to make a note of the basic setting. This way, it can be used as the starting point for subsequent, optimised settings and to safeguard against unintentional changes.

6.4.1 Adjusting the negative deflection

Negative deflection (SAG) is compression of the fork caused by the weight of the rider and their gear (e.g. a backpack), the sitting position and the frame geometry. This "SAG" is not caused by riding.

Each rider has a different weight and sitting position. "SAG" depends on the rider's position and weight and should be between 15% and 30% of the maximum fork deflection, depending on bicycle usage and preferences.

6.4.1.1 Adjusting the air suspension fork negative deflection *Alternative*

- The air valve is located under a cover on the head of the left shock absorber. Screw off the cover.



Figure 51: Screw caps in different designs

- Screw a high-pressure pump onto the valve.
- Pump the suspension fork up to the desired pressure. Never exceed the recommended maximum air pressure. Comply with the values of the filling pressure table.

Before the first ride

- ▶ Remove the high-pressure pump.

| Rider weight | AION, NEX | XCR 32, XCR 34 |
|---------------|--------------|----------------|
| < 55 kg | 35 - 50 psi | 40 - 55 psi |
| 55 - 65 kg | 50 - 60 psi | 55 - 65 psi |
| 65 - 75 g | 60 - 70 psi | 65 - 75 psi |
| 75 - 85 kg | 70 - 85 psi | 75 - 85 psi |
| 85 - 95 kg | 85 - 100 psi | 85 - 95 psi |
| < 100 kg | + 105 psi | + 100 psi |
| Max. pressure | 150 psi | 180 psi |

Table 25:

Filling pressure pump of the Suntour air forks

- ▶ Measure the distance between the crown and the dust wiper of the fork. This distance is the total deflection of the fork.
- ▶ Push a temporarily attached cable tie downward against the dust wiper of the fork.
- ▶ Put on your usual bicycling clothing, including luggage.
- ▶ Sit on the bicycle in your usual riding position and support yourself (e.g. against a wall or tree).
- ▶ Get off the bicycle without allowing it to deflect.
- ▶ Measure the distance between the dust wiper and the cable tie. This dimension is the "SAG." The "SAG" value should be between 15% (hard) and 30% (soft) of the total fork deflection.
- ▶ Increase or reduce the air pressure until you have reached the desired "SAG."

Before the first ride

⇒ Once the "SAG" is correct, re-tighten the blue air cover cap clockwise.



If you cannot achieve the desired "SAG", you may need to make an internal adjustment. For this purpose, contact your specialist dealer.

6.4.1.2

Adjusting the steel suspension fork negative deflection **Alternative**

You can adjust the fork by tensioning the spring to the rider's weight and their preferred riding style. It is not the coil spring hardness which is adjusted; it is its pre-tensioning. This reduces the fork's negative deflection when the rider sits on the bicycle.



Figure 52:

Negative deflection setting wheel on the suspension fork crown

- ▶ The setting wheel may be located under a plastic cover on the suspension fork crown. Remove the plastic cover by pulling it off upwards.
- ▶ Turn the negative deflection setting wheel in a clockwise direction to increase the spring pre-tensioning. Turn the negative deflection setting wheel in an anti-clockwise direction to reduce it.

Before the first ride

- ⇒ The ideal setting in relation to the weight of the rider has been achieved when the shock absorber deflects 3 mm under the stationary load of the rider. Reattach the cover after the adjustment.

6.4.2 Adjusting the rebound *Alternative*

The rebound defines the speed at which the fork rebounds after being loaded. The rebound setting depends on the air pressure setting. Higher "SAG" settings require lower rebound settings.

- ▶ Turn the rebound adjuster clockwise to the closed position until it stops.

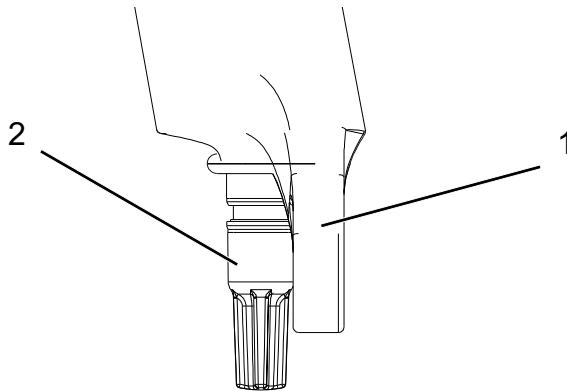

Figure 53: Suntour rebound adjuster (2) on the fork (1)

- ▶ Turn the rebound adjuster anti-clockwise.
- ⇒ Adjust the rebound in such a way that the fork rebounds quickly, but without bottoming out upward during testing. Bottoming out is where the fork rebounds too quickly and stops moving abruptly once it has reached the full rebound distance. You will hear and feel a slight knock when this occurs.

Before the first ride

6.5 **Adjusting the suspension of the FOX fork** *Alternative*



Crash caused by incorrectly set suspension

If the suspension is adjusted incorrectly, the fork may become damaged, so that problems may occur when steering. This will result in a crash and injuries.

- ▶ Never ride the bicycle without air in the air suspension fork.
 - ▶ Never use the bicycle without adjusting the suspension fork to the rider's weight.
-

NOTICE

Settings on the chassis change riding performance significantly. You need to get used to the bicycle and break it in to prevent accidents.

The adjustment shown here represents a basic setting. The rider should change the basic setting to suit the surface and his/her preferences.

- ▶ It is advisable to make a note of the basic setting. This way, it can be used as the starting point for subsequent, optimised settings and to safeguard against unintentional changes.
-

6.5.1 **Adjusting the negative deflection**

Negative deflection (SAG) is compression of the fork caused by the weight of the rider and their gear (e.g. a backpack), the sitting position and the frame geometry. This "SAG" is not caused by riding. Each rider has a different weight and sitting position. "SAG" depends on the rider's position and weight and should be between 15% and 20% of the maximum fork deflection, depending on bicycle usage and preferences.

 Before the first ride

- ✓ When adjusting the "SAG", ensure that each compression adjuster is in the open position, i.e. turned clockwise until it stops.
- ✓ The pressure is to be measured at an ambient temperature of 21 to 24 °C.
- ▶ The air valve is located under a blue cover on the head of the left shock absorber. Screw off the cover anti-clockwise.
- ▶ Place a high-pressure pump on the valve.
- ▶ Pump the suspension fork up to the desired pressure. Never exceed the recommended maximum air pressure. Comply with the values of the filling pressure table.
- ▶ Remove the high-pressure pump.

| Rider weight | Rhythm 34 | Rhythm 36 |
|-----------------------------|--------------------------|--------------------------|
| Minimum air pressure | 40 psi (2.8 bar) | 40 psi (2.8 bar) |
| 54 - 59 kg | 58 psi | 55 psi |
| 59 - 64 kg | 63 psi | 59 psi |
| 64 - 68 kg | 68 psi | 63 psi |
| 68 - 73 kg | 72 psi | 67 psi |
| 73 - 77 kg | 77 psi | 72 psi |
| 77 - 82 kg | 82 psi | 76 psi |
| 82 - 86 kg | 86 psi | 80 psi |
| 86 - 91 kg | 91 psi | 85 psi |
| 91 - 95 kg | 96 psi | 89 psi |
| 95 - 100 kg | 100 psi | 93 psi |
| 100 - 104 kg | 105 psi | 97 psi |
| 104 - 109 kg | 110 psi | 102 psi |
| 109 - 113 kg | 114 psi | 106 psi |
| Max. pressure | 120 psi (8.3 bar) | 120 psi (8.3 bar) |

Table 26:

Filling pressure table of the FOX air fork

Before the first ride

- ▶ Measure the distance between the crown and the dust wiper of the fork. This distance is the "total deflection of the fork."
 - ▶ Push the O-ring downward against the dust wiper of the fork. If an O-ring is not available, attach a cable tie to the stanchion temporarily.
 - ▶ Put on your usual bicycling clothing, including luggage.
 - ▶ Sit on the bicycle in your usual riding position and support yourself (e.g. against a wall or tree).
 - ▶ Get off the bicycle without allowing it to deflect.
 - ▶ Measure the distance between the dust wiper and the O-ring or cable tie. This dimension is the "SAG." The recommended "SAG" value is between 15% (hard) and 20% (soft) of the "total fork deflection."
 - ▶ Increase or reduce the air pressure until you have reached the desired "SAG."
- ⇒ Once the "SAG" is correct, re-tighten the blue air cover cap clockwise.



If you cannot achieve the desired "SAG", you may need to make an internal adjustment. For this purpose, contact your specialist dealer.

6.5.2 Adjusting the rebound

The rebound defines the speed at which the fork rebounds after being loaded. The rebound setting depends on the air pressure setting. Higher "SAG" settings require lower rebound settings.

- ▶ Turn the rebound adjuster clockwise to the closed position until it stops.

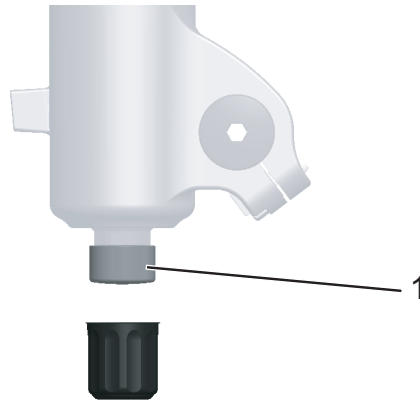

Figure 54:

FOX rebound adjuster (1) on the fork

- ▶ Turn the rebound adjuster anti-clockwise.
- ⇒ Adjust the rebound in such a way that the fork rebounds quickly, but without bottoming out upward during testing. Bottoming out is where the fork rebounds too quickly and stops moving abruptly once it has reached the full rebound distance. You will hear and feel a slight knock when this occurs.

Before the first ride

6.6 **Adjusting the Suntour rear frame damper** *Alternative*

6.6.1 **Adjusting the negative deflection**

NOTICE

If the air pressure in the rear frame damper is exceeded or undershot, the damper can be permanently damaged.

Do not exceed the maximum air pressure of 300 psi (20 bar).

Negative deflection (SAG) is compression of the rear frame damper caused by the weight of the rider and their gear (e.g. a backpack), the sitting position and the frame geometry. This "SAG" is not caused by riding. Each rider has a different weight and sitting position. "SAG" depends on the rider's position and weight and should be between 25% and 30% of the maximum rear frame damper deflection, depending on bicycle usage and preferences.

- ▶ Set the compression adjuster to the OPEN position so that the SAG setting is not affected.
- ▶ Remove the cap on the air valve.
- ▶ Attach a high-pressure damper pump to the valve.
- ▶ Adjust the air pressure of the damper so that it corresponds to your weight.
- ▶ Remove the high-pressure pump.
- ▶ Measure the distance between the rubber air chamber seal and the end of the damper. This distance is the "total damper deflection".
- ▶ Put on your usual bicycling clothing, including luggage. Sit on the bicycle in your usual riding position and support yourself, e.g. against a wall or tree.

Before the first ride

- ▶ Push the O-ring downward against the rubber air chamber seal.
- ▶ Get off the bicycle without allowing it to deflect.
- ▶ Measure the distance between the rubber air chamber seal and the O-ring. This dimension is the "SAG." The recommended "SAG" value is between 15% (hard) and 25% (soft) of the "total damper deflection."
- ▶ Increase or reduce the air pressure until you have reached the desired "SAG."

6.6.2 Adjusting the rebound

The rebound defines the speed at which the rear frame damper rebounds after being loaded. The rebound setting depends on the air pressure setting. Higher "SAG" settings require lower rebound settings.



Figure 55: Suntour rebound adjuster wheel (1) on the rear frame damper

- ▶ Turn the rebound adjuster wheel in the – direction to increase rebounding.
- ▶ Turn the rebound adjuster wheel in the + direction to reduce compressive deflection movements.

Before the first ride

6.6.3 Setting the compression

The compression damper setting of the rear frame damper makes it possible to set the damper according to the conditions of the ground. The compression damper setting specifies the speed at which the rear frame damper deflects after being loaded.

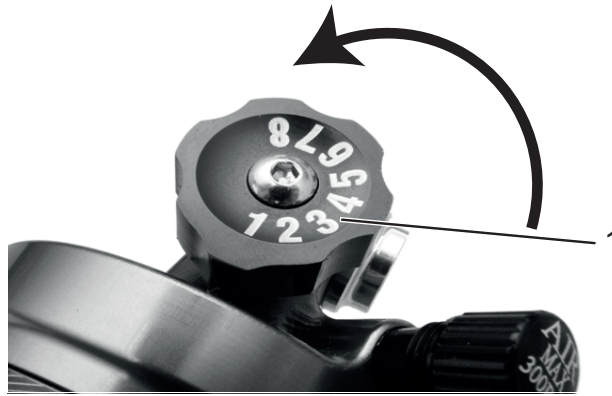

Figure 56: Suntour compression adjuster wheel (1) on the rear frame damper

- ▶ Turn the rebound adjuster wheel in the – direction to increase rebounding.
- ▶ Turn the rebound adjuster wheel in the + direction to reduce compressive deflection movements.

Before the first ride

6.7 **Adjusting the FOX rear frame damper** *Alternative*

6.7.1 **Adjusting the negative deflection**

NOTICE

If the air pressure in the rear frame damper is exceeded or undershot, the damper can be permanently damaged.

Do not exceed the maximum air pressure of 350 psi (24.1 bar). The minimum air suspension pressure of 50 psi (3.4 bar) must be complied with.

Negative deflection (SAG) is compression of the rear frame damper caused by the weight of the rider and their gear (e.g. a backpack), the sitting position and the frame geometry. This "SAG" is not caused by riding. Each rider has a different weight and sitting position. "SAG" depends on the rider's position and weight and should be between 25% and 30% of the maximum rear frame damper deflection, depending on bicycle usage and preferences.

- ▶ Set the compression adjuster to the OPEN position.
- ▶ Adjust the air pressure of the damper so that it corresponds to your weight.
- ▶ Attach the high-pressure pump to the damper. Slowly compress the damper over 25% of the deflection 10 times until you have reached the desired pressure. This equalises the air pressure between the positive and negative air chambers, and the pressure indication on the pump manometer changes accordingly.

Remove the high-pressure pump.

Before the first ride

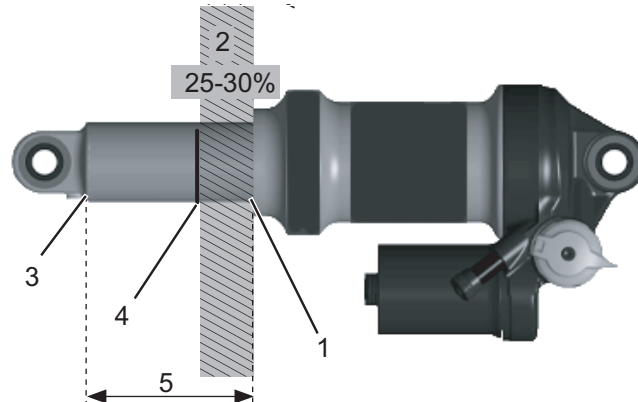

Figure 57: FOX rear frame damper

The negative deflection (2) is the distance between the O-ring (4) and the rubber air chamber seal (1). The total deflection of the rear frame damper (5) is the distance between the end of the rear frame damper (3) and the rubber air chamber seal (1)

- ▶ Measure the distance between the rubber air chamber seal (1) and the end of the damper (3). This distance is the "total damper deflection" (5).
- ▶ Put on your usual bicycling clothing, including luggage. Sit on the bicycle in your usual riding position and support yourself, e.g. against a wall or tree.
- ▶ Push the O-ring (4) downward against the rubber air chamber seal (1).
- ▶ Get off the bicycle without allowing it to deflect.

Before the first ride

- ▶ Measure the distance between the rubber air chamber seal and the O-ring. This dimension is the "SAG." The recommended "SAG" value is between 25% (hard) and 30% (soft) of the "total damper deflection" (5).
- ▶ Increase or reduce the air pressure until you have reached the desired "SAG."

6.7.2 Adjusting the rebound

The rebound defines the speed at which the rear frame damper rebounds after being loaded. The rebound setting depends on the air pressure setting. Higher "SAG" settings require lower rebound settings.

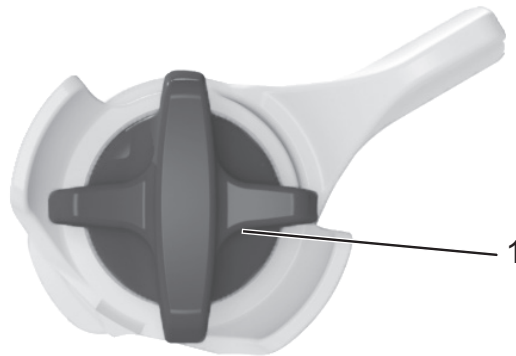

Figure 58: FOX rebound adjuster (1) on the rear frame damper

- ▶ Turn the rebound adjuster clockwise to the closed position until it stops.
- ▶ Determine your rebound setting based on the air pressure. Turn the rebound adjuster back anti-clockwise by the number of clicks specified in the table below:

Before the first ride

| Air pressure (psi) | Recommended rebound setting |
|--------------------|-----------------------------|
| < 100 | Open (anti-clockwise) |
| 100 - 120 | 11 |
| 120 - 140 | 10 |
| 140 - 160 | 9 |
| 160 - 180 | 8 |
| 180 - 200 | 7 |
| 200 - 220 | 6 |
| 220 - 240 | 5 |
| 240 - 260 | 4 |
| 260 - 280 | 3 |
| 280 - 300 | 2 |

Table 27: Filling pressure table of the FOX air fork

6.8 Adjusting the drive system

The drive system can be adapted to the rider's needs by changing the system settings. To do so, the settings menu must be open.

6.8.1 Opening the settings menu

- ✓ The bicycle is stationary.
- ▶ Press and hold the **button (display)**.

The *settings menu* is opened.



Figure 59: Settings menu

 Before the first ride

The settings menu comprises 11 sub-items:

| | Screen display | Function |
|----|------------------------|---|
| | CLEAR | Clear trip distance |
| | CLOCK | Clock settings |
| | BLUETOOTH LE | Bluetooth LE pairing |
| | BLUETOOTH LE/ANT | Bluetooth LE/ANT connection status |
| | LIGHT | Switch light on |
| | BRIGHTNESS | Brightness setting for backlight |
| | BEEP | Switch the beep on and off |
| 8 | UNIT | Switch between kilometres and miles |
| 9 | LANGUAGE | Language setting |
| 10 | ADJUST | Adjust the electronic gear shift |
| 11 | RD PROTECTION RESET | Activate the rear derailleur protection |
| | EXIT | Return to the main screen |

6.8.1.1

Clearing the settings

The settings and values for the journey distance, time, average speed and maximum speed can be cleared together at the same time.

- ✓ The *settings menu* is opened.
- ▶ Pull the **long assistance lever** or **short assistance lever** repeatedly until SET is highlighted.
- ⇒ Press the **button (display)**. There are two selection options.

| Screen display | Function |
|----------------|--------------------------------|
| EXIT | Returning to the settings menu |
| DST | Clearing the journey distance |

Table 28:

Journey information setting options

Before the first ride

- ▶ Pull the **long assistance lever** or **short assistance lever** repeatedly until TRIP is highlighted.
- ▶ Press the **button (display)**.
- ⇒ All setting values have been cleared. The *settings menu* is displayed.

6.8.1.2

Setting the time

- ✓ The *settings menu* is opened.
- ▶ Pull the **long assistance lever** or **short assistance lever** repeatedly until TIME is highlighted.
- ▶ Press the **button (display)**.
- ⇒ The set time is displayed. The hour indicator is highlighted.
- ▶ Press the **long assistance lever** to reduce the hours and press the **short assistance lever** to increase the hours until the hour you require is displayed. You can change the values quickly by keeping the **long assistance lever** or **short assistance lever** pressed down.
- ▶ Press the **button (display)**.
- ⇒ The minute indicator is highlighted.
- ▶ Press the **long assistance lever** to reduce the minutes and press the **short assistance lever** to increase the minutes until the minute you require is displayed. You can change the values quickly by keeping the **long assistance lever** or **short assistance lever** pressed down.
- ▶ Press the **button (display)**.
- ⇒ The time has been set. The *settings menu* is displayed.



6.8.1.3 Setting Bluetooth LE

The display can be connected with a tablet PC via Bluetooth for diagnosis and a software update. This function is only available to specialist dealers.

6.8.1.4 Bluetooth LE/ANT

The current status of the wireless connection can be shown on the display. This function is only available to specialist dealers.

6.8.1.5

Setting the light

- ✓ The *settings menu* is opened.
- ▶ Pull the **long assistance lever** or **short assistance lever** repeatedly until LIGHT is highlighted.
- ▶ Press the **button (display)**.
- ⇒ There are two selection options.

| Screen display | Function |
|----------------|-----------------------------|
| ON | Switch light on constantly |
| OFF | Switch light off constantly |

Table 29:

Journey information setting options

- ▶ Pull the **long assistance lever** or **short assistance lever** repeatedly until the required function is highlighted.
- ▶ Press the **button (display)**.
- ⇒ The highlighted function is carried out. The *settings menu* is displayed.

Before the first ride

6.8.1.6

Setting the brightness of the backlight

- ✓ The *settings menu* is opened.
- ▶ Pull the **long assistance lever** or **short assistance lever** until BRIGHTNESS is highlighted.
- ▶ Press the **button (display)**.
- ⇒ 5 different brightness values can be selected.
- ▶ Pull the **long assistance lever** or **short assistance lever** until the required value is highlighted.
- ▶ Press the **button (display)**.
- ⇒ The highlighted brightness value has been set. The *settings menu* is displayed.

6.8.1.7

Setting the beep sound

- ✓ The *settings menu* is opened.
- ▶ Pull the **long assistance lever** or **short assistance lever** until BEEP is highlighted.
- ▶ Press the **button (display)**.
- ⇒ There are two selection options:

| Screen display | Function |
|----------------|----------------------------|
| ON | Activate the beep signal |
| OFF | Deactivate the beep signal |

Table 30:

Beep signal setting options

- ▶ Pull the **long assistance lever** or **short assistance lever** repeatedly until the required function is highlighted.
- ▶ Press the **button (display)**.
- ⇒ The highlighted function has been set. The *settings menu* is displayed.

6.8.1.8**Changing the units**

- ✓ The *settings menu* is opened.
- ▶ Pull the **long assistance lever** or **short assistance lever** until UNIT is highlighted.
- ▶ Press the **button (display)**.
- ⇒ There are two selection options

| Screen display | Function |
|----------------|----------------------------|
| KM | Display distances in km |
| MILE | Display distances in miles |

Table 31:**Units of measure setting options**

- ▶ Pull the **long assistance lever** or **short assistance lever** until the required unit of measure is highlighted.
- ▶ Press the **button (display)**.
- ⇒ The highlighted unit of measure has been set. The *settings menu* is displayed.

6.8.1.9**Changing the language**

- ✓ The *settings menu* is opened.
- ▶ Pull the **long assistance lever** or **short assistance lever** until LANGUAGE is highlighted.
- ▶ Press the **button (display)**.
- ⇒ Six different languages can be selected: English, French, German, Dutch, Italian and Spanish.
- ▶ Pull the **long assistance lever** or **short assistance lever** until the required language is highlighted.
- ▶ Press the **button (display)**.
- ⇒ The highlighted language has been set. The *settings menu* is displayed.

Before the first ride

6.8.1.10 Setting the gear shift



CAUTION

Crash caused by incorrectly set gear shift

An incorrect, excessively broad setting can cause the bike to free-wheel while the rider is pedalling, possibly resulting in a crash. This will result in a crash and injuries.

- ▶ Only make this setting if the gear shift is not functioning normally. Under normal conditions, an unnecessary change of settings may impair the gear shift function.
-



The gear shift is adjusted in the *settings menu* with the menu item ADJUST. Special knowledge and tools are required for setting the gear shift. Only a specialist dealer may make these settings.

6.8.1.11

Resetting the rear derailleur

NOTICE

- ▶ Before the rear derailleur protective function is reset, the rear derailleur has to be inspected closely. Never reset the rear derailleur protective function if the rear derailleur is bent, broken or damaged.
-

The bicycle has a rear derailleur protective function to protect the gear shift in case of crashes. The rear derailleur protective function is triggered if the bicycle is exposed to a severe impact. The rear derailleur protective function briefly breaks the connection between the motor and the chain link. This renders the rear derailleur inoperable.

Resetting the rear derailleur protective function re-establishes the connection between the motor and the chain and restores the shift function.

- ✓ The *settings menu* is opened.

Before the first ride

- ▶ Press the **up button (left)** or **down button (left)** repeatedly until REAR DERAILLEUR RESET is displayed.
- ▶ Press the **action button (left)**.
- ⇒ There are two selection options:

| Screen display | Function |
|----------------|--|
| OK | Reset the rear derailleur protective function |
| CANCEL | Do not reset the rear derailleur protective function |

Table 32:

Units of measure setting options

- ▶ Press the **up button (left)** or **down button (left)** until the desired function is highlighted.
- ▶ Press the **action button (left)**.
- ⇒ The highlighted function has been set. If OK is selected, the connection between the motor and the crank is re-established.
- ⇒ The *settings menu* is displayed.

6.8.1.12

Closing the settings menu

- ▶ Pull the **long assistance lever** or **short assistance lever** repeatedly until EXIT is highlighted.
- ▶ Press the **button (display)**.
- ⇒ The *settings menu* is closed.

6.9

Retracting the brake linings

New brake linings take time to break in and adjust to their final braking force.

- ▶ Accelerate bicycle to about 25 km/h.
- ▶ Brake bicycle until it comes to a halt.
- ▶ Repeat process 30–50 times.
- ▶ The brake linings and brake discs are now retracted and provide optimal braking power.

Operation

7 Operation



Crash caused by loose clothing

Laces, scarves and other loose items may become entangled in the spokes on the *wheels* and the *chain drive*. This may cause you to fall from the bicycle and injure yourself.

- ▶ Wear sturdy footwear and close-fitting clothing.



Risk of fire and burning due to hot motor

The motor housing becomes hot when riding. Touching it may cause burns to the skin or other objects.

- ▶ Never touch the motor housing directly after riding.
- ▶ Never place the bicycle on a flammable surface (grass, wood, etc.) directly after use.



Crash caused by soiling

Heavy soiling can impair the functions of the bicycle, for example, the function of the brakes. This may cause you to fall from the bicycle and injure yourself.

- ▶ Remove coarse soiling before riding.



Crash caused by poor road conditions

Loose objects, such as branches and twigs, may become caught in the wheels and cause a crash with injuries.

- ▶ Be aware of the road conditions.
- ▶ Ride slowly and brake in good time.



When riding downhill, high speeds may be reached. The bicycle is only engineered for exceeding a speed of 25 km/h briefly. In particular, the *tyres* can fail if exposed to a continuous load.

- ▶ Decelerate the bicycle with the brakes, if higher speeds than 25 km/h are reached.

NOTICE

Heat or direct sunlight can cause the *tyre pressure* to increase above the permitted maximum pressure. This can destroy the *tyres*.

- ▶ Never park the bicycle in the sun.
- ▶ On hot days, regularly check the *tyre pressure* and adjust it as necessary.

You can be ride the bicycle within a temperature range between 5 °C and 35 °C. The effectiveness of the drive system is restricted outside of this temperature range.

Operation temperature 5 °C - 35 °C

Moisture penetrating at low temperatures may impair individual bicycle functions due to the open structural design.

- ▶ Always keep the bicycle dry and free from frost.
- ▶ If the bicycle is to be used at temperatures below 3 °C, the specialist dealer must carry out an inspection and prepare the bicycle for winter usage first.

Off-road riding subjects the joints in the arms to severe strain. Take a break from riding every 30 to 90 minutes, depending on the condition of the roads.



Operation

7.1 Before each ride



Crash caused by difficult-to-spot damage

If the bicycle topples over or you have a fall or an accident, there may be difficult-to-spot damage to components such as the brake system, quick releases or *frame*. This may cause you to fall from the bicycle and injure yourself.

- ▶ Take the bicycle out of service and have a specialist dealer carry out an inspection.
-



Crash caused by material fatigue

Intensive use can cause material fatigue. A component may suddenly fail in case of material fatigue. This may cause you to fall from the bicycle and injure yourself.

- ▶ Remove the bicycle from service immediately in case of any signs of material fatigue. Have the specialist dealer check the state.
- ▶ Have the specialist dealer carry out a basic inspection regularly. During the inspection, the specialist dealer inspects the bicycle for any signs of material fatigue on the frame, fork, suspension element mountings (if there are any) and components made of composite materials.

Carbon becomes brittle when exposed to heat radiation such as heating. This can cause the carbon part to break and result in a crash with injuries.

- ▶ Never expose carbon parts to strong heat sources.
-

7.2

Check list before each ride

► Check the bicycle before each ride.

⇒ Do not use the bicycle if there are any anomalies.

| | |
|--------------------------|--|
| <input type="checkbox"/> | Check that the bicycle is complete. |
| <input type="checkbox"/> | Check that the lighting, reflector and brake, for instance, are sufficiently clean. |
| <input type="checkbox"/> | You must check that the mudguards, the pannier rack and the chain guard are securely installed. |
| <input type="checkbox"/> | Check that the front and rear wheels run true. This is particularly important if the bicycle has been transported or secured with a lock. |
| <input type="checkbox"/> | Check the valves and the tyre pressure. Adjust as necessary before each ride. |
| <input type="checkbox"/> | If the bicycle has a hydraulic rim brake, check whether the locking levers are fully closed in their final positions. |
| <input type="checkbox"/> | Check the front and rear wheel brakes to make sure that they are working properly. To do so, operate the brake levers while stationary in order to check whether resistance is generated in the usual brake lever position. The brake must not lose any brake fluid. |
| <input type="checkbox"/> | Check that the driving light is working. |
| <input type="checkbox"/> | Check for unusual noises, vibrations, smells, staining, deformation, cracks, scores, abrasion and wear. This indicates material fatigue. |
| <input type="checkbox"/> | Inspect suspension system for cracks, dents, bumps, parts or leaking oil. Look at concealed sections on the bicycle's lower surfaces. |
| <input type="checkbox"/> | Use body weight to compress suspension system. Adjust to the optimum "SAG" value if suspension is too soft. |
| <input type="checkbox"/> | If quick releases are used check them to make sure that they are fully closed in their end position. If quick release axle systems are used, make sure that all attachment screws are tightened to the correct torque. |
| <input type="checkbox"/> | Be alert to any unusual operating sensations when braking, pedalling or steering. |

Operation

7.3 Using the kickstand



CAUTION

Crash caused by a lowered kickstand

The kickstand does not fold up automatically. There is a risk of crashing if riding with the kickstand lowered.

- ▶ Raise the kickstand completely before the ride.

NOTICE

The heavy weight of the bicycle may cause the kickstand to sink into soft ground and the bicycle may topple and crash over.

- ▶ The bicycle must be parked on firm, level ground only.
- ▶ It is particularly important to check that the bicycle is stable if it is equipped with accessories or loaded with luggage.

Raising the kickstand

- ▶ Before the ride, raise the kickstand completely with your foot.

Parking the bicycle

- ▶ Before parking, lower the kickstand completely with your foot.
- ▶ Park the bicycle carefully and check that it is stable.

7.4 Using the pannier rack



Crash caused by loaded pannier rack

The riding performance of the bicycle changes with a loaded *pannier rack*, in particular when steering and braking. This can lead to a loss of control. This may cause you to fall from the bicycle and injure yourself.

- ▶ You should practice how to use a loaded *pannier rack* safely and reliably before using the bicycle in public spaces.



Crash caused by unsecured luggage

Loose or unsecured objects on the *pannier rack*, e.g. belts, may become caught in the rear wheel. This may cause you to fall from the bicycle and injure yourself.

Objects which are fastened to the pannier rack may cover the bicycle's *reflectors* and the *driving light*. The bicycle may be overseen on public roads. This may cause you to fall from the bicycle and injure yourself.

- ▶ Secure any objects which are attached to the *pannier rack* sufficiently.
- ▶ Objects fastened to the *pannier rack* must never cover the *reflectors*, the *headlight* or the *rear light*.



Crushing the fingers in the spring flap

The spring flap on the *pannier rack* operates with a high clamping force. There is a risk of crushing the fingers.

- ▶ Never allow the spring flap to snap shut in an uncontrolled manner.
- ▶ Be careful where you position your fingers when closing the spring flap.

Operation

NOTICE

The maximum load bearing capacity is indicated on the *pannier rack*.

- ▶ Never exceed the permitted *total weight* when packing the bicycle.
 - ▶ Never exceed the maximum load bearing capacity of the *pannier rack*.
 - ▶ Never modify the *pannier rack*.
-
- ▶ Distribute the luggage as evenly as possible on the left and right-hand side of the bicycle.
 - ▶ We recommend the use of panniers and luggage baskets.

7.5 Rechargeable battery



Fire and explosion due to defective battery

The safety electronics may fail on a damaged or faulty battery. The residual voltage can cause a short circuit. The battery may self-ignite and explode.

- ▶ Remove batteries with external damage from service immediately and never charge them.
- ▶ If the battery becomes deformed or begins to smoke, keep at a safe distance, disconnect the power supply at the socket, and notify the fire service immediately.
- ▶ Never extinguish damaged batteries with water or allow them to come into contact with water.
- ▶ If a battery is dropped or struck but shows no signs of external damage, remove it from service and observe it for at least 24 hours.
- ▶ Faulty batteries are hazardous goods. Dispose of faulty batteries properly and as quickly as possible.
- ▶ Store the battery in a dry place until disposal. Never store in the vicinity of flammable substances.
- ▶ Never open or repair the battery.



Risk of fire and explosion due to high temperatures

Excessively high temperatures will damage the battery. The battery may self-ignite and explode.

- ▶ Protect the battery against heat.
- ▶ Never expose the battery to sustained direct sunlight.

Operation



Fire and explosion caused by short circuit

Small metal objects may jumper the electrical connections of the battery. The battery may self-ignite and explode.

- ▶ Keep paper clips, screws, coins, keys and other small parts away and do not insert them into the battery.



Chemical burns to the skin and eyes caused by faulty battery

Liquids and vapours may leak from damaged or faulty batteries. They can irritate the airways and cause burns.

- ▶ Avoid contact with leaked liquids.
- ▶ Ventilate with fresh air and consult a doctor if you suffer any pain or discomfort.
- ▶ Immediately consult a doctor in case of contact with the eyes or any discomfort.
- ▶ In case of contact with the skin, rinse off immediately with water.
- ▶ Ventilate the room well.



Fire and explosion caused by incorrect charger

Batteries which are recharged with an unsuitable charger may become damaged internally. This may result in fire or an explosion.

- ▶ Only ever use the battery with the supplied charger.
- ▶ Mark the supplied charger and these operating instructions clearly to prevent mix-ups – with the *bicycle frame number* or *type number*, for example.

**Fire and explosion caused by penetration by water**

The battery is only protected from simple spray water. Penetration by water can cause a short circuit. The battery may self-ignite and explode.

- ▶ Never immerse the battery in water.
- ▶ If there is reason to believe that water may have entered into the battery, the battery must be removed from service.

NOTICE

If a key is left inserted when transporting the bicycle, or when riding, it may break off or the compartment may open accidentally.

- ▶ Remove the key from the battery lock immediately after use.
- ▶ We recommend that you attach the key to a key ring.

7.5.1**Side down tube battery**

- ✓ Switch off the battery and the drive system before removing or inserting the battery.

7.5.1.1**Inserting the battery**

Figure 60: Positioning battery (1) on mount (2)

Operation

- ▶ Place the battery on the contacts in the lower mount. Push the battery inwards.
 - ⇒ There is an audible clicking noise.
- ▶ Secure the battery by closing. Remove the key.
- ▶ Check the inserted battery to make sure it is fastened and firmly in place.

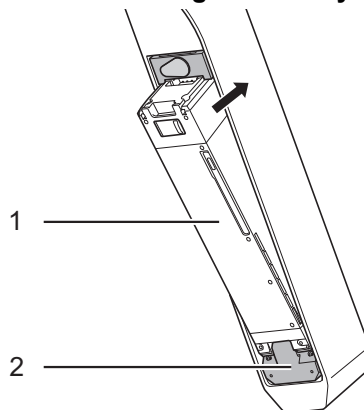
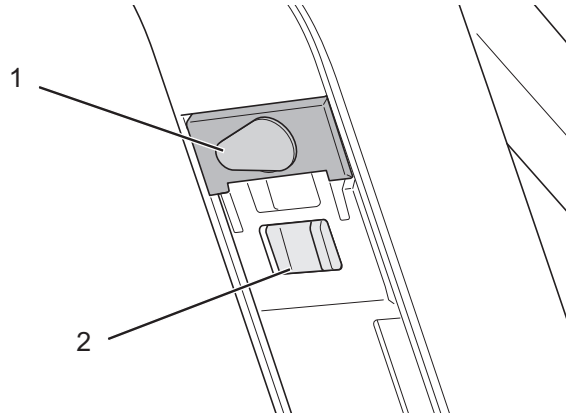

Figure 61:

Closed key cover (1) and charge cap (2)

- ▶ Before setting off, ensure that the key cover and charge cap are closed.

7.5.1.2**Removing the battery**

- ▶ Remove key cover.
- ▶ Insert key into the key cylinder in the battery mount. The position of the key has no effect on the battery mount. You can insert the key in any position. You cannot remove the key if it is not in the insert position.

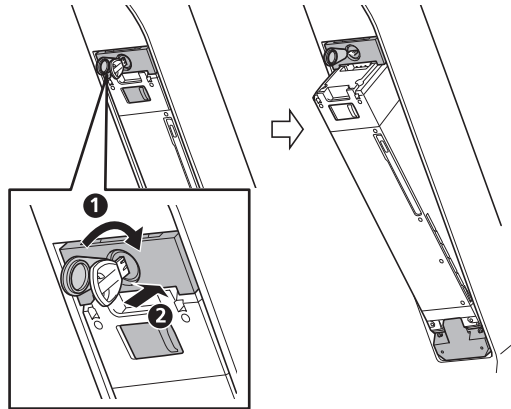
**Figure 62:****Removing and inserting the down tube battery**

- ▶ Turn the key in a clockwise direction to unlock the battery (1) and press the key into place (2).
- ⇒ The battery is unfastened
- ▶ Support the battery in your hand to ensure that it won't fall out.
- ▶ Remove the key and re-insert the battery lock cover.
- ▶ Remove the battery by removal handle.

Operation

7.5.2 Charging the battery

CAUTION

Fire caused by overheated charger

The charger heats up when charging the battery. In case of insufficient cooling, this can result in fire or burns to the hands.

- ▶ Never use the charger on a highly flammable surface (e.g. paper, carpet etc.).
 - ▶ Never cover the charger during the charging process.
-

CAUTION

Electric shock caused by penetration by water

If water penetrates into the charger, there is a risk of electric shock.

- ▶ Never charge the battery outdoors.
-

CAUTION

Electric shock in case of damage

Damaged chargers, cables and plug connectors increase the risk of electric shock.

- ▶ Check the charger, cable and plug connector before each use. Never use a damaged charger.
 - ▶ The ambient temperature during the charging process must be within the range from 0 °C to 40 °C.
-

Charging temperature 0 °C - 40 °C

- ✓ Recharge the battery on a flat surface in a closed room.
- ✓ The battery can remain on the bicycle or be removed for charging.
- ✓ Interrupting the charging process does not damage the battery.
- ✓ On a bicycle which is equipped with two batteries, the charging process for both batteries is started from the pannier rack battery.
- ▶ If included, remove the rubber cover from the battery.

 Operation

- ▶ Connect the charging cable to the battery's charging port.
- ▶ Connect the mains plug of the charger to a normal domestic, grounded socket.

Connection data 230 V, 50 Hz

- ⇒ The charging process starts automatically.
- ▶ The LED light on the charger will light up once charging starts.

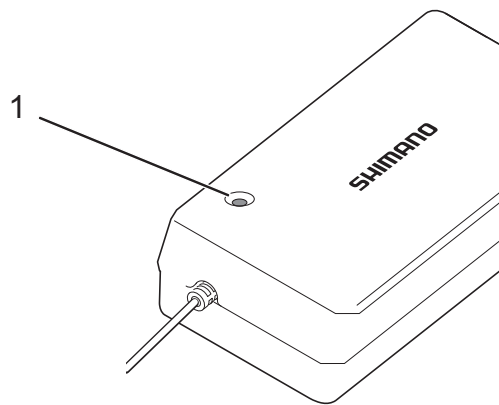





Figure 63:

LED light on the charger

The LED light on the charger has three statuses:

| | Status | Meaning |
|---|--------------|--|
|  | Lit | The charger is recharging the battery. |
|  | Flashing | There is a charging error. |
|  | Switched off | |

Operation

CAUTION **Risk of fire and explosion caused by damaged batteries.** The safety electronics on damaged or faulty batteries may fail. The residual voltage can cause a short circuit. The batteries may self-ignite and explode. If the battery becomes deformed or begins to smoke, keep at a safe distance, disconnect the power supply at the socket, and notify the fire service immediately. Never extinguish damaged batteries with water or allow them to come into contact with water.

NOTICE If an error occurs during the charging process, a system message is displayed. Remove the charger and the battery from operation immediately and follow the instructions.

- ▶ You can check the current charge status by looking at the LEDs on the battery. The LED statuses are lit (■), non-lit (□) and flashing (▨).
- ▶ You can check the current charging status by pressing the battery's On-Off switch.







| | |
|---|--|
|  | 100 - 81% |
|  | 80 - 61% |
|  | 60 - 41% |
|  | 40 - 21% |
|  | 20 - 1% |
|  | 0% when the battery is not fitted to the bicycle |
|  | 0% when the battery is fitted to the bicycle |

Table 33:

Battery charge status

- ⇒ The charging process is complete when the LEDs of the operating and charge status indicator go out.

7.6 Electric drive system

7.6.1 Switching on the drive system



Crash caused by lack of readiness for braking

When it is switched on, the drive system can be activated by the application of force on the pedals. There is a risk of a crash if the drive is activated unintentionally, and the brake is not reached.

▶ Never start the electric drive system, or switch it off immediately, if the brake cannot be reached safely and reliably.

- ✓ A sufficiently charged battery has been inserted on the bicycle.
- ✓ Never place your feet on the pedals when switching on. If the pedals are moved when switching on, a system error is caused.
- ✓ The battery is firmly in place. The key has been removed.
- ✓ The system cannot be switched on while charging.

There are 2 options for switching on the drive system:

Switching on using the display

- ▶ Press and hold the **On-Off button (display)** for 2 seconds.

Switching on using the display

- ▶ Press the **On-Off button (battery)** briefly.
- ⇒ The LED light will light up and indicate the remaining battery capacity.
- ⇒ If the drive system is switched on, the drive is activated as soon as the pedals are moved with sufficient force.

Operation

7.6.2

Switching off the drive system

The system switches off automatically ten minutes after the last command.

There are 2 options for switching off the drive system:

Switching off using the display

- ▶ Press and hold the **On-Off button (display)** for 2 seconds.

Switching off using the battery

- ▶ Press and hold the **On-Off button (battery)** for 6 seconds.
- ⇒ If the drive system is switched on, the drive is activated as soon as the pedals are moved with sufficient force.

7.7 Display

7.7.1 Using the driving light

The driving light is either constantly on or constantly off. The setting is changed in the system settings.

7.7.2 Using the push assist system

NOTICE

The pedals turn when using the push assist due to the system design.

- ▶ You must steer the bicycle securely with both hands when using push assist.
- ▶ Allow for enough freedom of movement for the pedals.

The push assist helps the rider to push the bicycle. The speed can be a maximum of 6 km/h in this case. The tractive power of the push assist and its speed can be influenced by the selection of gear. We recommend using first gear for cycling uphill to protect the drive.

Select Walk level of assistance

- ▶ Pull the **long assistance lever** for a long time.
 - ⇒ The level of assistance WALK is displayed.
 - ⇒ If a warning is sounded during switchover, it is impossible to switch to the WALK level of assistance. This may be due to the current speed not being 0 km/h, pressure being applied to the pedals or similar.
- ▶ Release the **long assistance lever**.

Switching on push assist

- ▶ Pull the **long assistance lever** to switch on the push assist system.

Operation

Switching off the push assist

- ▶ Release the **long assistance lever** to switch off the push assist system.

Exit Walk level of assistance

- ▶ Pull the **short assistance lever** to change from the WALK level of assistance to the level of assistance last used.
- ▶ If the **long assistance lever** is not pulled for longer than one minute, the level of assistance is reset to the level of assistance used previously.

7.7.3

Selecting the level of assistance

- ▶ Pull the **long assistance lever** briefly to increase the level of assistance.
- ▶ Press the **short assistance lever** to reduce the level of assistance.

7.7.4 Switching journey information

The displayed journey information can be changed.

- ▶ Press the **info button (display)** repeatedly until the desired item of *journey information* is displayed.

| Screen display | Function |
|----------------|---|
| DST | Distance travelled since the last reset |
| ODO | Display of the total distance travelled (cannot be changed) |
| RANGE* | Anticipated range of the available battery charge |
| TIME | Trip time |
| AVG | Average speed |
| MAX | Maximum achieved speed |
| CADENCE | Number of crank revolutions per minute |
| CLOCK | Clock |

Table 34: Journey information

*1 The battery charge status is not displayed if RANGE is displayed. The range should be used for guidance purposes only.

*2 If the push assistance function is activated, the on-screen indicator switches from [RANGE] to [RANGE ---].

⇒ When journey information is shown, the display returns to the speed screen after 60 seconds.

7.7.4.1 Clearing the displayed distance travelled

- ✓ The *settings menu* is opened.
- ▶ Pull the **long assistance lever** or **short assistance lever** repeatedly until CLEAR is highlighted.
- ▶ Press the **button (display)**.

Operation

⇒ There are two selection options:

| Screen display | Function |
|----------------|---|
| EXIT | Return to the <i>settings menu</i> |
| DST | Delete the displayed distance travelled |

Table 35:

Journey information setting options

- ▶ Pull the **long assistance lever** or **short assistance lever** until the required function is highlighted.
 - ▶ Press the **button (display)**.
- ⇒ The highlighted function is carried out. The *settings menu* is displayed.

7.8 Gear shift

The selection of the appropriate gear is a prerequisite for a physically comfortable ride and making sure that the electric drive system functions properly. The ideal pedalling frequency is between 40 and 60 revolutions per minute.

7.8.1 Selecting a higher gear manually

▶ Press the **short shifter**.

⇒ The gear shift is switched up one gear.

7.8.2 Selecting a lower gear manually

▶ Press the **long shifter**.

⇒ The gear shift is switched down one gear.

Operation

7.9

Brake



Hydraulic fluid can be fatal if it is swallowed and penetrates into the respiratory system

Hydraulic fluid may leak out after an accident or due to material fatigue. Hydraulic fluid can be fatal if swallowed and inhaled.

First aid treatment

- ▶ Wear gloves and safety goggles as protective equipment. Keep unprotected persons away.
- ▶ Remove those affected from the danger area to fresh air. Never leave those affected unattended.
- ▶ Ensure sufficient ventilation.
- ▶ Immediately remove clothing items contaminated with hydraulic fluid.
- ▶ Serious slip hazard due to hydraulic fluid leakage.
- ▶ Keep away from naked flames, hot surfaces and sources of ignition.
- ▶ Avoid contact with skin and eyes.
- ▶ Do not inhale vapours or aerosols.

After inhalation

- ▶ Take in fresh air; consult doctor if any pain or discomfort.

After skin contact

- ▶ Wash affected skin with soap and water and rinse well. Remove contaminated clothing. Consult doctor if any pain or discomfort.
-

After contact with eyes

- ▶ Rinse eyes under flowing water for at least ten minutes with the lids open; also rinse under lids. Consult eye doctor if pain or discomfort continues.

After ingestion

- ▶ Rinse out mouth with water Never induce vomiting! Risk of aspiration!
- ▶ Place a person lying on their back who is vomiting in a stable recovery position on their side. Seek medical advice immediately.

Environmental protection measures

- ▶ Never allow hydraulic fluid to flow into the sewage system, surface water or groundwater.
- ▶ Notify the relevant authorities if fluid penetrates the ground or pollutes water bodies or the sewage system.

**Amputation due to rotating brake disc**

The brake disc in disc brakes is so sharp that it can cause serious injuries to fingers if they are inserted into the disc brake openings.

- ▶ Always keep fingers well away from the rotating brake disc.

Operation



Crash caused by brake failure

Oil or lubricant on the brake disc in a disc brake or on the rim of a rim brake can cause the brake to fail completely. This may cause a crash with serious injuries as a consequence.

- ▶ Never allow oil or lubricant to come into contact with the brake disc or brake linings or on the rim of a rim brake.
- ▶ If the brake linings have come into contact with oil or lubricant, contact a dealer or a workshop to have the components cleaned or replaced.

If the brakes are applied continuously for a long time (e.g. while riding downhill for a long time), the fluid in the brake system may heat up. This may create a vapour bubble. This will cause air bubbles or any water contained in the brake system to expand. This may suddenly make the lever travel wider. This may cause a crash with serious injuries.

- ▶ Release the brake regularly when riding downhill for a longer period of time.



Crash caused by wet conditions

The *tyres* may slip on wet roads. In wet conditions you must also expect a longer braking distance. The braking sensation differs from the usual sensation. This can cause loss of control or a crash, which may result in injuries.

- ▶ Ride slowly and brake in good time.
-

**Crash caused by incorrect use**

Handling the brake improperly can lead to loss of control or crashes, which may result in injuries.

- ▶ Shift your body weight back and down as far as possible.
- ▶ Practise braking and emergency braking before the bicycle is used in public spaces.
- ▶ Never use the bicycle if you can feel no resistance when pulling on the brake handle. Consult a specialist dealer.

**Crash after cleaning or storage**

The brake system is not designed for use on a bicycle which is placed on its side or turned upside down. The brake may not function correctly as a result. This can cause a crash, which may result in injuries.

- ▶ If the bicycle is placed on its side or turned upside down, apply the brake a couple of times before setting off to ensure that it functions normally.
- ▶ Never use the bicycle if it no longer brakes as normal. Consult a specialist dealer.

**Burns caused by heated brake**

The brakes may become very hot during operation. There is a risk of burns or fire in case of contact.

- ▶ Never touch the components of the brake directly after the ride.

Operation

The drive force of the motor is shut off during the ride as soon as the rider no longer pedals. The drive system does not switch off when braking.

- ▶ In order to achieve optimum braking results, do not pedal while braking.

7.9.1 Using the brake lever

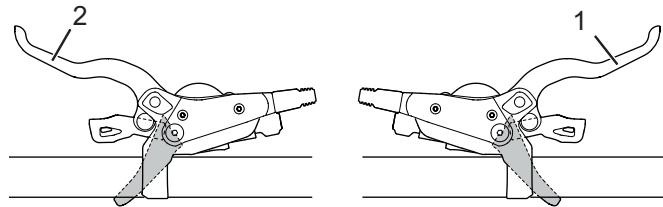

Figure 64: Front (2) and rear (1) brake lever; Shimano brake used as an example

- ▶ Pull the left *brake lever for the front wheel brake* and the right lever for the rear wheel brake until the desired speed is reached.

7.9.2 Using the back-pedal brake *Alternative*

- ✓ The best braking effect is achieved if the pedals are in the 3 o'clock and 9 o'clock position when braking. To bridge the free travel between the riding movement and the braking movement, it is recommendable to pedal a little beyond the 3 o'clock and 9 o'clock position before you pedal in the opposite direction to the *direction of travel* and start braking.
- ▶ Pedal in the opposite direction to the *direction of travel* until the desired speed has been reached.

7.10 Suspension and damping

7.10.1 Adjusting the compression of the Suntour fork *Alternative*

The compression adjuster makes it possible to make quick adjustments to the suspension behaviour of the fork to suit changes in terrain. It is intended for adjustments made during the ride.



Figure 65: Suntour compression adjuster with the OPEN (1) and LOCK (2) positions

- Compression damping is lowest in the OPEN position, making the fork feel softer. Use the LOCK position if you want the fork to feel stiffer and you are riding on soft ground. The lever positions between the OPEN and LOCK positions enable fine adjustment of compression damping.

We recommend setting the lever of the compression adjuster to the OPEN position first.

Operation

7.10.2 Adjusting the compression of the Fox fork *Alternative*

The compression adjuster makes it possible to make quick adjustments to the suspension behaviour of the fork to suit changes in terrain. It is intended for adjustments made during the ride.

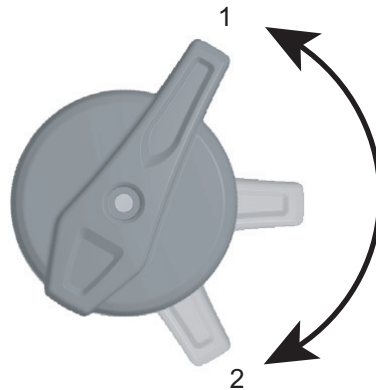

Figure 66: FOX compression adjuster with the OPEN (1) and HARD (2) positions

- Compression damping is lowest in the OPEN position, making the fork feel softer. Use the HARD position if you want the fork to feel stiffer and you are riding on soft ground. The lever positions between the OPEN and HARD positions enable fine adjustment of compression damping.

We recommend setting the lever of the compression adjuster to the OPEN mode position first.

7.10.3

Adjusting the compression of the Suntour damper *Alternative*

The compression adjuster makes it possible to make quick adjustments to the suspension behaviour of the damper to suit changes in terrain. It should never be used while riding on rough terrain.



Figure 67:

Suntour compression adjuster open (1)

- ▶ Use the OPEN position for rough descents and the LOCK position for efficient climbing. First set the compression adjuster to the OPEN position.



Figure 68:

Suntour compression adjuster closed (2)

Operation

7.10.4 Adjusting the compression of the Fox damper *Alternative*

The compression adjuster makes it possible to make quick adjustments to the suspension behaviour of the damper to suit changes in terrain. It is intended for adjustments made during the ride.

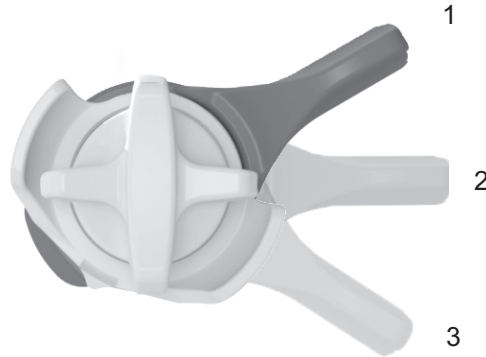

Figure 69: FOX compression adjuster on the rear frame damper with the OPEN (1), MEDIUM (2) and HARD (3) positions

- Use the OPEN position for rough descents, the MEDIUM position for uneven terrain and the HARD position for efficient climbing. First set the compression adjuster to the OPEN position.

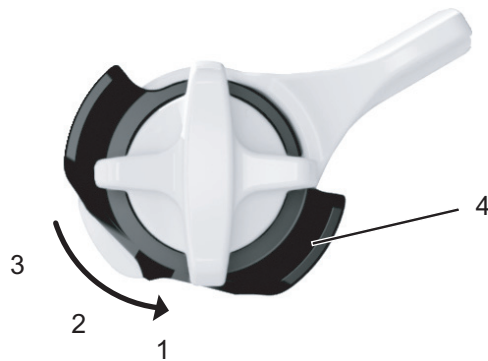

Figure 70: Fine adjustment of the OPEN position is made using the adjuster (4)

Operation

The FOX rear frame damper features fine adjustment for the OPEN position.

- ✓ We recommend that fine adjustments be made when the compression adjuster is in the MEDIUM or HARD position.
- ▶ Pull out the adjuster.
- ▶ Turn the adjuster to position 1, 2 or 3. Setting 1 is for the softest riding performance, whereas 3 is for the hardest.
- ▶ Press the adjuster in to lock in the setting.

Maintenance

8 Maintenance

Cleaning check list

| | | |
|--------------------------|--|---------------------------|
| <input type="checkbox"/> | Clean pedals | after each ride |
| <input type="checkbox"/> | Clean suspension fork and, if necessary, rear frame damper | after each ride |
| <input type="checkbox"/> | Clean battery | once a month |
| <input type="checkbox"/> | Chain (mainly tarmacked road) | every 250–300 km |
| <input type="checkbox"/> | Basic cleaning and preservation of all components | at least every six months |
| <input type="checkbox"/> | Clean the charger | at least every six months |
| <input type="checkbox"/> | Clean and lubricate height-adjustable seat post | every six months |

Maintenance check list

| | | |
|--------------------------|--|---------------------------|
| <input type="checkbox"/> | Check USB rubber cover position | before each ride |
| <input type="checkbox"/> | Check for tyre wear | once a week |
| <input type="checkbox"/> | Check for rim wear | once a week |
| <input type="checkbox"/> | Check the tyre pressure | once a week |
| <input type="checkbox"/> | Check brakes for wear | once a month |
| <input type="checkbox"/> | Check electrical cables and Bowden cables for damage and ensure they are fully functional | once a month |
| <input type="checkbox"/> | Check the chain tension | once a month |
| <input type="checkbox"/> | Check the tension of the spokes | every three months |
| <input type="checkbox"/> | Check the gear shift setting | every three months |
| <input type="checkbox"/> | Check suspension fork and, if necessary, rear frame damper for wear and ensure they are fully functional | every three months |
| <input type="checkbox"/> | Check for wear on brake discs | at least every six months |

Maintenance

Service check list

| | | |
|--------------------------|---|---|
| <input type="checkbox"/> | Functional check on the suspension fork | every 50 hours |
| <input type="checkbox"/> | Suspension fork maintenance and dismantling | every 100 hours or at least once a year |
| <input type="checkbox"/> | Complete maintenance of the rear frame damper | every 125 hours |
| <input type="checkbox"/> | Inspection by the specialist dealer | every six months |
| <input type="checkbox"/> | Inspection of the drive unit | 15,000 km |

Maintenance

8.1 Cleaning and servicing



Crash and falling caused by unintentional activation

There is a risk of injury if the drive system is activated unintentionally.

- ▶ Remove before cleaning.
-

The following servicing measures must be performed regularly. Servicing can be performed by the operator and rider. In case of any doubt, consult the specialist dealer.

8.1.1 After each ride

8.1.1.1 Cleaning the suspension fork

- ▶ Remove dirt and deposits on the stanchions and deflector seals with a damp cloth.
- ▶ Check the stanchions for dents, scratches, staining or leaking oil.
- ▶ Check the air pressure.
- ▶ Lubricate the dust seals and stanchions.

8.1.1.2 Cleaning the rear frame damper

- ▶ Remove dirt and deposits from the damper body with a damp cloth.
- ▶ Check rear frame damper for dents, scratches, staining or leaking oil.

8.1.1.3 Cleaning the pedals

- ▶ Clean with a brush and soapy water after riding through dirt or rain.
- ⇒ Service the pedals after cleaning.

8.1.2 Basic cleaning



CAUTION

Crash caused by brake failure

The braking effect may be unusually poor temporarily after cleaning, servicing or repairing the bicycle. This may cause you to fall from the bicycle and injure yourself.

- ▶ Never apply care products or oil to the brake discs or brake linings, or the braking surfaces on the rims.
- ▶ After cleaning, servicing or repair, carry out a few test brake applications.

NOTICE

Water may enter into the inside of the bearings if you use a steam jet. This dilutes the lubricant inside, the friction increases and, as a result, the bearings are permanently damaged in the long term.

- ▶ Never clean the bicycle with a steam jet.

NOTICE

Greased parts, such as the seat post, the handlebars or the stem, may no longer be safely and reliably clamped.

- ▶ Never apply grease or oil to clamping sections.
- ✓ Remove battery and display before basic cleaning.

8.1.2.1 Cleaning the frame

- ▶ Soak dirt stains on the frame with dish-washing detergent if the dirt is thick and ingrained.
- ▶ After leaving it to soak for a time, remove the dirt and mud with a sponge, brush and toothbrush.
- ▶ Use a watering can or your hand to rinse the frame to finish off.
- ▶ Service the frame after cleaning.

Maintenance

8.1.2.2

Cleaning the stem

- ▶ Clean stem with a cloth and washing water.
- ▶ Service the stem after cleaning.

8.1.2.3

Cleaning the rear frame damper

- ▶ Clean rear frame damper with a cloth and washing water.

8.1.2.4

Cleaning the wheel



WARNING

Crash caused by braking hard on rims

A rim can break and block the wheel if you brake hard. It may cause a crash with serious injuries.

- ▶ Check rim wear on a regular basis.
- ▶ Check the tyres, rims, spokes and spoke nipples for any damage when cleaning the wheel.
- ▶ Use a sponge and a brush to clean the hub and spokes from the inside to the outside.
- ▶ Clean the rim with a sponge.

8.1.2.5

Cleaning the drive elements

- ▶ Spray the cassette, the chain wheels and the front derailleur with a degreasing agent.
- ▶ Clean coarse dirt with a brush after soaking for a short time.
- ▶ Wash down all parts with dish-washing detergent and a toothbrush.
- ▶ Service the drive elements after cleaning.

8.1.2.6**Cleaning the chain****NOTICE**

- ▶ Never use aggressive (acid-based) cleaners, rust removers or degreasers when cleaning the chain.
- ▶ Do not use chain cleaning devices or chain cleaning baths.
- ▶ Slightly dampen a brush with dish-washing liquid. Brush both sides of the chain.
- ▶ Dampen a cloth with dish-washing liquid. Place the cloth on the chain.
- ▶ Hold with slight pressure while slowly turning the rear wheel, so the chain passes through the cloth.
- ▶ If the chain is still dirty afterwards, clean it with WD40.
- ▶ Service the chain after cleaning.

8.1.2.7**Cleaning the battery****Fire and explosion caused by penetration by water**

The battery is only protected from simple spray water. Penetration by water can cause a short circuit. The battery may self-ignite and explode.

- ▶ Never clean the battery with a high-pressure water device, water jet or compressed air.
- ▶ Never immerse the battery in water.
- ▶ Never use cleaning agents.
- ▶ Remove the battery from the bicycle before cleaning.
- ▶ Clean the battery electrical connections with a dry cloth or brush only.
- ▶ Wipe off the decorative sides with a damp cloth.

Maintenance

8.1.2.8 Cleaning the display

NOTICE

If water enters into the display, it will be permanently damaged.

- ▶ Never immerse the display in water.
 - ▶ Never clean with a high-pressure water device, water jet or compressed air.
 - ▶ Never use cleaning agents.
 - ▶ Remove the display from the bicycle before cleaning.
-
- ▶ Carefully clean the display with a damp, soft cloth.

8.1.2.9 Cleaning the drive unit



CAUTION

Burns from hot drive

The drive cooler can become extremely hot during use. Contact may cause burns.

- ▶ Leave the drive unit to cool before cleaning.
-

NOTICE

If water enters into the drive unit, the unit will be permanently damaged.

- ▶ Never immerse the drive unit in water.
 - ▶ Never clean with a high-pressure water device, water jet or compressed air.
 - ▶ Never use cleaning agents.
 - ▶ Never open.
-
- ▶ Carefully clean the drive unit with a damp, soft cloth.

8.1.2.10

Cleaning the brake



Brake failure due to water penetration

The brake seals are unable to withstand high pressures. Damaged brakes can fail and cause an accident with injury.

- ▶ Never clean the bicycle with a high-pressure water device or compressed air.
 - ▶ Take great care when using a hosepipe. Never point the water jet directly at the seal section.
-
- ▶ Clean brake and brake discs with a brush, water and dish-washing detergent.
 - ▶ Clean brake discs thoroughly with brake cleaner or spirit.

8.1.3

Servicing

8.1.3.1

Servicing the frame

- ▶ Dry frame after cleaning
- ▶ Spray with care oil Clean off the care oil again after a short time.

8.1.3.2

Servicing the stem

- ▶ Apply silicone or Teflon oil to the stem shaft tube and the quick release lever pivot point.
- ▶ If you have speedlifter Twist, also apply oil to the unlocking bolt using the groove in the speedlifter body.
- ▶ Apply a little acid-free lubricant grease between the stem quick release lever and the sliding piece to reduce the quick release lever operating force.

8.1.3.3

Servicing the fork

- ▶ Treat the dust seals with fork oil

Maintenance

8.1.3.4

Servicing the drive elements

- ▶ Spray the cassette, the chain wheels and the front derailleur with a degreasing agent.
- ▶ Clean coarse dirt with a brush after soaking for a short time.
- ▶ Wash down all parts with dish-washing detergent and a toothbrush.

8.1.3.5

Servicing the pedal

- ▶ Treat with spray oil after cleaning.

8.1.3.6

Servicing the chain

- ▶ Grease the chain thoroughly with chain oil after cleaning.

8.1.3.7

Servicing the drive elements

- ▶ Service front and rear derailleur articulated shafts and jockey wheels with Teflon spray.

8.2

Maintenance

**CAUTION**

Crash and falling caused by unintentional activation

There is a risk of injury if the drive system is activated unintentionally.

- ▶ Remove the battery before maintenance.

The following maintenance measures must be carried out regularly [[▷ Check list, page 142](#)]. They can be carried out by the operator and rider. In case of any doubt, consult the specialist dealer.

8.2.1

Wheel

**WARNING**

Crash caused by braking hard on rims

A rim can break and block the wheel if you brake hard. It may cause a crash with serious injuries.

- ▶ Check rim wear on a regular basis.

**NOTICE**

If the pressure is too low in the tyre, the tyre does not achieve its load bearing capacity. The tyre is not stable and may come off the rim.

If the pressure in the tyre is too high, the tyre may burst.

- ▶ Check the tyre pressure against the specifications [[▷ Data sheet, page 1](#)]
- ▶ *Adjust the tyre pressure as necessary.*
- ▶ Check the *tyre wear*.
- ▶ Check the *tyre pressure*.
- ▶ Check the *rims* for wear.
- The rims of a rim brake with invisible wear indicator are worn as soon as the wear indicator becomes visible in the area of the rim joint.

Maintenance

- The rims with visible wear indicator are worn as soon as the black, all-round groove on the pad friction surface is no longer visible. We recommend that you also replace the *rims* with every second brake lining replacement.
- ▶ Check the tension of the spokes.

8.2.2

Brake system



Crash caused by brake failure

Worn brake discs and brake linings, as well as a lack of hydraulic fluid in the brake cable, reduce the braking power. This may cause you to fall from the bicycle and injure yourself.

- ▶ Check the brake disc, brake linings and the hydraulic brake system on a regular basis and replace if necessary.
-
- ▶ Replace the brake linings on the disc brake when the pad thickness has reached 0.5 mm.

8.2.3

Electrical cables and brake cables

- ▶ Check all visible electrical cables and cables for damage. If, for example, the sheathing is compressed, the bicycle will need to be removed from service until the cables have been replaced.
- ▶ Check all electrical cables and cables to make sure they are fully functional.

8.2.4

Gear shift

- ▶ Check the gear shift and the *shifter* or the *twist grip* setting and adjust it as necessary.

8.2.5

Stem

- ▶ The stem and quick release system should be inspected at regular intervals. The specialist dealer should adjust them if necessary.
- ▶ If the hexagon socket head screw is also loosened, the headset backlash also needs to be adjusted. Medium-strength thread locker, such as Loctite blue, then needs to be applied to the loosened screws and the screws tightened as per the instructions.
- ▶ Check for wear and signs of corrosion (maintain with an oily cloth) and for oil leaks.

8.2.6

Checking the chain and belt tension

NOTICE

Excessive chain or belt tension increases wear.

If the chain or belt tension is too low, there is a risk that the *chain* or belt will slip off the *chain wheels*.

- ▶ Check the chain or belt tension once a month.
 - ▶ Check the chain or belt tension in three or four positions, turning the crank a full revolution.
 - ▶ If the *chain* or the belt can be pushed more than 2 cm, you need to have the *chain* or belt tensioned again by the specialist dealer.
 - ▶ If the *chain* or belt can only be pushed up and down less than 1 cm, you will need to slacken the *chain* or belt slightly.
- ⇒ The ideal chain or belt tension has been achieved if the *chain* or the belt can be pushed a maximum of 2 cm in the middle between the pinion and the toothed wheel. The crank must also turn without resistance.



Maintenance

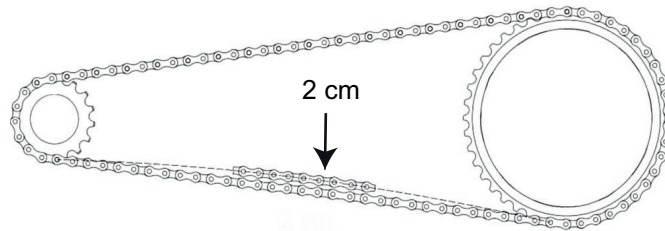

Figure 71: Checking the chain and belt tension



- ▶ If a hub gear is featured, the rear wheel must be pushed backwards or forwards to tighten the chain. This should be done by a specialist only.

8.2.7

USB port

NOTICE

Any moisture which enters through the USB port may trigger a short circuit in the *display*.

- ▶ Regularly check the position of the *cover on the USB port* and adjust it as necessary.

8.2.8

Suspension fork



- ▶ The specialist dealer will check the suspension fork function and the torques of attachment screws and nuts on the lower surfaces (steel: 10 Nm; alloy: 4 Nm). They will check the suspension fork for scratches, dents, cracks, stains, oil leaks or signs of wear or corrosion.

8.3

Service

 **WARNING**

Injury to the eyes

Problems may arise if the settings are not made properly and you may sustain serious injuries as a result.

- ▶ Always wear safety glasses to protect your eyes when carrying out maintenance work such as replacing components.

 **CAUTION**

Crash and falling caused by unintentional activation

There is a risk of injury if the drive system is activated unintentionally.

- ▶ Remove the battery before inspection.

 **CAUTION**

Crash caused by material fatigue

If the service life of a component has expired, the component may suddenly fail. This may cause you to fall from the bicycle and injure yourself.

- ▶ Have the specialist dealer carry out six-monthly basic cleaning of the bicycle, preferably at the same time as the required servicing work.

NOTICE

The motor is maintenance-free and may only be opened by qualified specialist personnel.

- ▶ Never open the motor.

Maintenance

Servicing must be performed by the specialist dealer at least every six months. This is the only way to ensure that the bicycle remains safe and fully functional.



- ▶ The specialist dealer will inspect the bicycle for any signs of material fatigue during basic cleaning.
- ▶ The specialist dealer will check the software version of the drive system and update it. The electrical connections are checked, cleaned and preservative agent is applied. The electrical cables are inspected for damage.



- ▶ The specialist dealer will dismantle and clean the entire suspension fork interior and exterior. They will clean and lubricate the dust seals and slide bushings, check the torques and adjust the fork to the rider's preferred position. They will also replace the sliding collar if the clearance is too great (more than 1 mm on the fork bridge).
- ▶ The specialist dealer will fully inspect the interior and exterior of the rear frame damper, overhaul the rear frame damper, replace all air seals of air forks, overhaul the air suspension, change the oil and replace the dust wipers.
- ▶ The further servicing measures correspond to those which are recommended for a bicycle as per EN 4210. Particular attention is paid to the rim and brake wear. The spokes are re-tightened in accordance with the findings.

8.4 Adjusting and repairing

WARNING

Injury to the eyes

Problems may arise if the settings are not made properly and you may sustain serious injuries as a result.

- ▶ Always wear safety glasses to protect your eyes when carrying out maintenance work such as replacing components.

CAUTION

Crash and falling caused by unintentional activation

There is a risk of injury if the drive system is activated unintentionally.

- ▶ Remove the battery before inspection.

8.4.1 Use original parts and lubricants only

The individual parts of the bicycle have been selected carefully and to matched to each other.

Only original parts and lubricants must be used for maintenance and repair.

The constantly updated lists of approved accessories and parts are available to specialist dealers.

Maintenance

8.4.2 Axle with quick release



Crash caused by unfastened quick release

A faulty or incorrectly installed quick release may become caught in the brake disc and block the wheel. This will cause a crash.

- ▶ Install the front wheel quick release lever on the opposite side to the brake disc.



Crash caused by faulty or incorrectly installed quick release

The brake disc becomes very hot during operation. Parts of the quick release may become damaged as a result. The quick release comes loose. This will result in a crash and injuries.

- ▶ The front wheel quick release lever and the brake disc must be situated on opposite sides.



Crash caused by incorrectly set clamping force

Excessively high clamping force will damage the quick release and cause it to lose its function.

Insufficient clamping force will cause a detrimental transmission of force. The suspension fork or the frame may break. This will result in a crash and injuries.

- ▶ Never fasten a quick release using a tool (e.g. hammer or pliers).
 - ▶ Only use the clamping lever with the specified set clamping force.
-

8.4.2.1

Checking the quick release

- ▶ Check the position and clamping force of the quick release lever. The quick release lever must be flush with the lower housing. You must be able to see a slight impression on the palm of your hand when you close the quick release lever.



Figure 72:

Adjusting the quick release clamping force

- ▶ Use a 4 mm hexagon socket spanner to adjust the clamping lever clamping force if required. Afterwards, check the quick release lever position and clamping force.

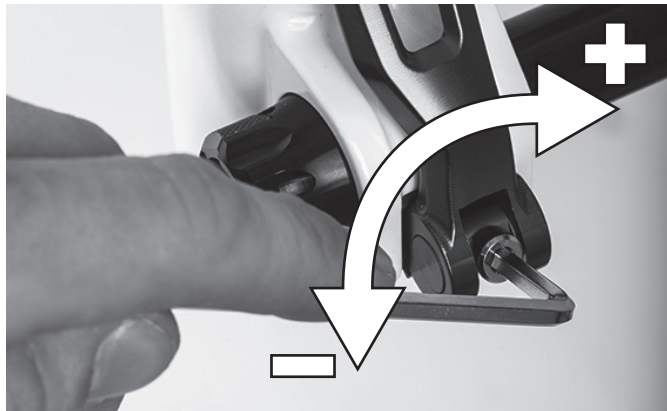

Figure 73:

Adjusting the quick release clamping force

Maintenance

8.4.3 Adjusting the tyre pressure

8.4.3.1 Dunlop valve

The tyre pressure cannot be measured on the simple Dunlop valve. The tyre pressure is therefore measured in the filling hose when pumping slowly with the bicycle pump.

- ✓ It is recommendable to use a bicycle pump with a pressure gauge. The operating instructions for the bicycle pump must be adhered to.
- ▶ Unscrew and remove the valve cap.
- ▶ Connect the bicycle pump.
- ▶ Pump up the tyre slowly and pay attention to the tyre pressure in the process.
- ⇒ The tyre pressure has been adjusted as per the data [▷ *Data sheet, page 1*].
- ▶ If the tyre pressure is too high, unfasten the union nut, let off air and tighten the union nut again.
- ▶ Remove the bicycle pump.
- ▶ Screw the valve cap tight.
- ✓ Screw the rim nut gently against the rim with the tips of your fingers.



Figure 74: Dunlop valve with union nut (1) and rim nut (2)

8.4.3.2

Presta valve

- ✓ It is recommendable to use a bicycle pump with a pressure gauge. The operating instructions for the bicycle pump must be adhered to.
- ▶ Unscrew and remove the valve cap.
- ▶ Open the knurled nut around four turns.
- ▶ Carefully apply the bicycle pump so that the valve insert is not bent.
- ▶ Pump up the tyre slowly and pay attention to the tyre pressure in the process.
- ⇒ The tyre pressure has been adjusted as per the data [[Data sheet, page 1](#)].
- ▶ Remove the bicycle pump.
- ▶ Tighten the knurled nut with your fingers.
- ▶ Screw the valve cap tight.
- ▶ Screw the rim nut gently against the rim with the tips of your fingers.



Figure 75:

Presta valve with valve insert (1), knurled nut (2) and rim nut (3)

Maintenance

8.4.3.3

Schrader valve

- ✓ It is recommendable to use a bicycle pump with a pressure gauge. The operating instructions for the bicycle pump must be adhered to.
- ▶ Unscrew and remove the valve cap.
- ▶ Connect the bicycle pump.
- ▶ Pump up the tyre slowly and pay attention to the tyre pressure in the process.
- ⇒ The tyre pressure has been adjusted as per the data [▷ *Data sheet, page 1*].
- ▶ Remove the bicycle pump.
- ▶ Screw the valve cap tight.
- ▶ Screw the rim nut gently against the rim with the tips of your fingers.



Figure 76:

Schrader valve with rim nut (1)

8.4.4 Reactivating the rear derailleur protection

The bicycle has a rear derailleur protective function to protect the gear shift in case of crashes. The rear derailleur protective function is triggered if the bicycle is exposed to a severe impact. The rear derailleur protective function briefly breaks the connection between the motor and the chain link. This renders the rear derailleur inoperable.

Resetting the rear derailleur protective function re-establishes the connection between the motor and the chain and restores the shift function. The *settings menu* is opened.

- ✓ The *settings menu* is opened.
- ▶ Press the **up button (left)** or **down button (left)** repeatedly until RD PROTECTION RESET is displayed.
- ▶ Press the **action button (left)**.
- ⇒ There are two selection options:

| Screen display | Function |
|----------------|--|
| OK | Reset the rear derailleur protective function |
| CANCEL | Do not reset the rear derailleur protective function |

Table 36:

Units of measure setting options

- ▶ Press the **up button (left)** or **down button (left)** until the desired function is highlighted.
- ▶ Press the **action button (left)**.
- ⇒ The highlighted function has been set. If OK is selected, the connection between the motor and the crank is re-established.
- ⇒ The *settings menu* is displayed.

Maintenance

8.4.4.1

Setting the gear shift



Crash caused by incorrectly set gear shift

An incorrect, excessively broad setting can cause the bike to free-wheel while the rider is pedalling, possibly resulting in a crash. This will result in a crash and injuries.

- ▶ Only make this setting if the gear shift is not functioning normally. Under normal conditions, an unnecessary change of settings may impair the gear shift function.
-



The gear shift is adjusted in the *settings menu* with the menu item ADJUST. Special knowledge and tools are required for setting the gear shift. Only a specialist dealer may make these settings.

8.4.5 Offsetting the brake lining wear

8.4.6 Hydraulically operated rim brake

Alternative

The *setting bolt* on the *brake lever* of the hydraulic rim brake is used to offset the brake lining wear. If the profile of the brake linings has a remaining depth of just 1 mm, the brake linings need to be replaced.

- ▶ In order to reduce the free travel and offset the brake lining wear, screw the *setting bolt* in.
 - ▶ In order to increase the free travel, screw the *setting bolt* out.
- ⇒ With the optimum setting the pressure point, i.e. the point at which the brake takes effect, is reached after 10 mm of free travel.



Figure 77: Brake lever (1) of the hydraulically operated rim brake with setting bolt (2)

Maintenance

8.4.7 Hydraulically operated disc brake

Alternative

The brake pad wear on the disc brake does not require readjustment.

8.4.8 Replacing the lighting

Alternatively a 3 watt or 1.5 watt lighting system can be installed.

- ▶ Only use components of the respective power class for replacement.

8.4.9 Setting the headlight

- ▶ The *headlight* must be set, so that its light beam meets the road 10 m in front of the bicycle.

8.4.10 Repair by the specialist dealer



Special knowledge and tools are required for many repairs. Only a specialist dealer may carry out the following repairs, for instance:

- Replacing *tyres* and rims,
- Replacing brake pads and brake linings
- Replacing and tensioning the *chain*.

8.4.11 Replacing the lighting

Alternatively a 3 watt or 1.5 watt lighting system can be installed.

- ▶ Only use components of the respective power class for replacement.

8.4.12 Setting the headlight

- ▶ The *headlight* must be set, so that its light beam meets the road 10 m in front of the bicycle.

8.4.13 Repair by the specialist dealer



Special knowledge and tools are required for many repairs. Only a specialist dealer may carry out the following repairs, for instance:

- Replacing *tyres* and rims,
- Replacing brake pads and brake linings,
- Replacing and tensioning the *chain*.

Maintenance

8.4.14

First aid



Fire and explosion due to faulty batteries

The safety electronics may fail if the battery is damaged or defective. The residual voltage can cause a short circuit. Batteries may self-ignite and explode.

- ▶ Batteries with external damage must be removed from service immediately.
- ▶ Never allow damaged batteries to come into contact with water.
- ▶ If a battery is dropped or struck but shows no signs of external damage, remove it from service and observe it for at least 24 hours.
- ▶ Faulty batteries are hazardous goods. Dispose of faulty batteries properly and as quickly as possible.
- ▶ Store in a dry place until disposal. Never store in the vicinity of flammable substances.
- ▶ Never open or repair the battery.

The components of the drive system are checked constantly and automatically. If an error is detected the corresponding error code will appear on the *display*. Depending on the type of error, the drive will also be automatically switched off.

8.4.15 The drive system or display do not start up

If the display and/or the drive system do not start up, proceed as follows:

- ▶ Check whether the battery is switched on. If not, start the battery.
- ⇒ Contact specialist dealer if the charge status indicator LEDs do not light up.
- ▶ If the LEDs of the charge status indicator light up, but the drive system does not start up, remove the battery.
- ▶ Insert the battery.
- ▶ Start the drive system.
- ▶ If the drive system does not start up, remove the battery.
- ▶ Clean all the contacts with a soft cloth.
- ▶ Insert the battery.
- ▶ Start the drive system.
- ▶ If the drive system does not start up, remove the battery.
- ▶ Fully charge the battery.
- ▶ Insert the battery.
- ▶ Start the drive system.
- ▶ If the drive system does not start up, remove the display.
- ▶ Fasten the display.
- ▶ Start the drive system.
- ▶ Contact your specialist dealer if the drive system does not start up.

Maintenance

8.4.15.1

System messages

If an error message is displayed, run through the following actions:

- ▶ Make a note of the system message.
- ▶ Shut off and re-start the drive system.
- ▶ If the system message is still displayed, remove and then re-insert the battery.
- ▶ Re-start the drive system.
- ▶ If the system message is still displayed, contact your specialist dealer.

8.4.15.2

Special system messages

- ▶ Make a note of the system message. You will find the complete system error list in the appendix.

| Code | Remedy |
|---------------|---|
| 410, 418 | ▶ Check whether buttons are jammed because dirt has got into them, for example. Clean the buttons if necessary. |
| 430 | ▶ Charge internal display battery. |
| 502 | <ul style="list-style-type: none"> ▶ Check the light and its cabling. ▶ Re-start the system. ▶ Contact your specialist dealer if the problem persists. |
| 530, 591, 655 | <ul style="list-style-type: none"> ▶ Turn off the drive system. ▶ Remove the battery. ▶ Insert the battery again. ▶ Re-start the system. ▶ Contact your specialist dealer if the problem persists. |

Table 37:

Error eradication using the code

Maintenance

| Code | Remedy |
|-------------------|--|
| 540, 605 | <ul style="list-style-type: none"> ▶ The bicycle is outside the permitted temperature range. ▶ Switch the bicycle off to cool the drive unit down or warm it up to the permitted temperature range. ▶ Re-start the system. ▶ Contact your specialist dealer if the problem persists. |
| 550 | <ul style="list-style-type: none"> ▶ Remove the electrical load. ▶ Re-start the system. ▶ Contact your specialist dealer if the problem persists. |
| 592 | <ul style="list-style-type: none"> ▶ Insert a compatible display. ▶ Re-start the system. ▶ Contact your specialist dealer if the problem persists. |
| 602 | <ul style="list-style-type: none"> ▶ Disconnect the charger from the battery. ▶ Re-start the system. ▶ Plug the charger into the battery. ▶ Contact your specialist dealer if the problem persists. |
| 605 | <ul style="list-style-type: none"> ▶ Disconnect the charger from the battery. ▶ Leave the battery to cool. ▶ Contact your specialist dealer if the problem persists. |
| 620 | <ul style="list-style-type: none"> ▶ Replace the charger. ▶ Contact your specialist dealer if the problem persists. |
| 656 | <ul style="list-style-type: none"> ▶ Contact your specialist dealer to install a software update. |
| 7xx | <ul style="list-style-type: none"> ▶ Please observe the manufacturer's operating instructions. |
| No screen display | <ul style="list-style-type: none"> ▶ Re-start your drive system by switching it on and off. |

Table 37:

Error eradication using the code

- ▶ If the system message is still displayed, contact your specialist dealer.

Maintenance

8.5 Accessories

For bicycles without a kickstand we recommend a parking stand into which either the front or rear wheel can be inserted securely. The following accessories are recommended:

| <i>Description</i> | <i>Article number</i> |
|--|-----------------------|
| Protective cover for electrical components | 080-41000 ff |
| Panniers, system component* | 080-40946 |
| Rear wheel basket, system component* | 051-20603 |
| Bicycle box, system component* | 080-40947 |
| Parking stand universal stand | XX-TWO14B |
| Lighting set, system component** | 070-50500 ff |

Table 38:

Accessories

*System components are matched to the pannier rack and provide sufficient stability due to special transmission of force.

**System components are matched to the drive system.

8.5.1 Child seat

WARNING Crash caused by incorrect child seat

Neither the pannier rack nor the bicycle down tube are suitable for child seats and may break. Such an incorrect position may cause a crash with serious injuries for the rider and the child.

- ▶ Never attach a child seat to the saddle, handlebars or down tube.

**Crash caused by improper handling**

When using child seats, the riding properties and the stability of the bicycle change considerably. This can cause a loss of control, a crash and injuries.

- ▶ You should practice how to use the child seat safely and reliably before using the bicycle in public spaces.

**Risk of crushing due to exposed springs**

The child may crush his/her fingers on exposed springs or open mechanical parts of the saddle or the seat post.

- ▶ Never install saddles with exposed springs if a child seat is being used.
- ▶ Never install seat posts with suspension with open mechanical parts or exposed springs if a child seat is being used.

NOTICE

- ▶ Observe the legal regulations on the use of child seats.
- ▶ Observe the operating and safety notes for the child seat system.
- ▶ Never exceed the total weight of the bicycle.

Maintenance



The specialist dealer will advise on choosing a suitable child seat system for the child and the bicycle.

The specialist dealer must mount the child seat the first time to ensure that it is safely fitted.

When installing a child seat, the specialist dealer makes sure that the seat and the fastening mechanism for the seat are suitable for the bicycle and that all components are installed and firmly fastened. They will also ensure that shift cables, brake cables, hydraulic and electrical cables are adjusted as necessary, the rider's freedom of movement is not restricted and the bicycle's permitted total weight is not exceeded.

The specialist dealer will provide instruction on how to handle the bicycle and the child seat.

8.5.2

Bicycle trailer



Crash caused by brake failure

The brake may not work sufficiently if there is an excessive trailer load. The long braking distance can cause a crash or an accident and injuries.

▶ Never exceed the specified trailer load.



▶ The operating and safety notes for the trailer system must be observed.

▶ The statutory regulations on the use of bicycle trailers must be observed.

▶ Only use type-approved coupling systems.

A bicycle which is approved for towing a trailer is equipped with the relevant information sign. Only bicycle trailers with a support load and total mass which do not exceed the permitted values must be used.

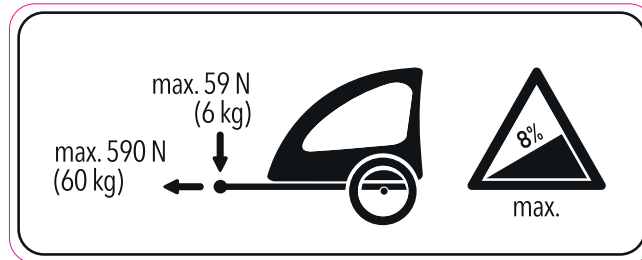

Figure 78:

Trailer sign

The specialist dealer will advise on choosing a suitable trailer system for the bicycle. The specialist dealer must install the trailer the first time to ensure that it is safely fitted.

8.5.3**Pannier rack**

The specialist dealer will advise on choosing a suitable pannier rack.

The specialist dealer must mount the pannier rack the first time to ensure that it is safely fitted.

When installing a pannier rack, the specialist dealer makes sure that the fastening mechanism for the rack is suitable for the bicycle and that all components are installed and firmly fastened. They will also ensure that shift cables, brake cables and hydraulic and electrical lines are adjusted as necessary, the rider's freedom of movement is not restricted and the permitted total weight of the bicycle is not exceeded.

The specialist dealer will provide instruction on how to handle the bicycle and the pannier rack.

Recycling and disposal

9 Recycling and disposal



Risk of fire and explosion

The safety electronics on damaged or faulty batteries may fail. The residual voltage can cause a short circuit. Batteries may self-ignite and explode.

- ▶ Remove batteries with external damage from service immediately and never charge them.
- ▶ If the battery becomes deformed or begins to smoke, keep at a safe distance, disconnect the power supply at the socket, and notify the fire service immediately.
- ▶ Never extinguish damaged batteries with water or allow them to come into contact with water.
- ▶ Faulty batteries are hazardous goods. Dispose of faulty batteries properly and as quickly as possible.
- ▶ Store in a dry place until disposal. Never store in the vicinity of flammable substances.
- ▶ Never open or repair the battery.



Chemical burns to the skin and eyes

Liquids and vapours may leak from damaged or faulty batteries. They can irritate the airways and cause burns.

- ▶ Avoid contact with leaked liquids.
 - ▶ Immediately consult a doctor in case of contact with the eyes or any discomfort.
 - ▶ In case of contact with the skin, rinse off immediately with water.
 - ▶ Ventilate the room well.
-

Recycling and disposal



This device is marked according to the European Directive 2012/19/EU on waste electrical and electronic equipment – WEEE and accumulators (Directive 2006/66/EC). The directive provides the framework for the EU-wide return and recycling of used devices, which are collected separately and in an environmentally sound manner.



The bicycle, battery, motor, display and charger are recyclable materials. You must dispose of and recycle them separately from domestic waste in compliance with the applicable statutory regulations.

Sorted waste collection and recycling saves on raw material reserves and ensures that all the regulations for health and environmental protection are met when the product and/or the battery are recycled.

- ▶ Never dismantle the bicycle, battery or charger for disposal.
- ▶ The bicycle, display, the unopened and undamaged battery and the charger can be returned to any specialist dealer free of charge. Depending on the region, further disposal options may be available.
- ▶ Store the individual parts of the decommissioned bicycle in a dry place, free from frost, where they are protected from direct sunlight.

Appendix

10 Appendix

10.1 Battery error message

The battery indicates errors with different LED statuses. The LED statuses are lit (■), non-lit (□) and flashing (▨).





| Type | Status | Lighting pattern | Remedy |
|--------------------------------------|--|---|--|
| System error | Communication error with the bicycle system. |  | <ul style="list-style-type: none"> ▶ Check that the charging cable is firmly and properly connected. ▶ Contact your specialist dealer if the problem persists. |
| Temperature protection | If the temperature exceeds the guaranteed operating range, the battery will switch off. |  | <ul style="list-style-type: none"> ▶ Store battery in a cool place where there is no direct sunlight until the battery interior temperature has fallen sufficiently. ▶ Contact your specialist dealer if the problem persists. |
| Error during security authentication | This is displayed if no original drive unit is connected. This is displayed if one of the cables is not connected. |  | <ul style="list-style-type: none"> ▶ Connect an original battery and an original drive unit. ▶ Check the status of the cables. ▶ Contact your specialist dealer if the problem persists. |
| Charge error | This is displayed if an error occurs during the charging process. |  | <ul style="list-style-type: none"> ▶ Remove the plug connector between the battery and charger. ▶ Press the On-Off button when only the battery is connected. ▶ Contact your specialist dealer if the problem persists. |
| Battery malfunction | Electrical fault in the battery. |  | <ul style="list-style-type: none"> ▶ Plug the charger into the battery. ▶ Remove the charger. ▶ Press the On-Off switch when the battery is connected. ▶ Contact your specialist dealer if the problem persists. |

Table 39: Battery error messages

10.2 Warning message

| Code | Cause | Limitation | Remedy |
|------|---|---|---|
| W010 | The drive unit temperature is higher than during normal operation. | Pedal assistance is possibly less than normal. | <ul style="list-style-type: none"> ▶ Do not use the assistance function any more until the drive unit temperature decreases. ▶ Contact your specialist dealer if the problem persists. |
| W011 | The bike's speed cannot be detected. | The maximum speed before pedal assistance is provided may be lower than normal. | <ul style="list-style-type: none"> ▶ Check that the speed sensor is fitted correctly. ▶ Contact your specialist dealer if the problem persists. |
| W013 | The torque sensor may not have initialized completely successfully. | Pedal assistance is possibly less than normal. | <ul style="list-style-type: none"> ▶ Take your foot off the pedal. ▶ Press the battery On-Off button and switch the system on again. ▶ Contact your specialist dealer if the problem persists. |
| W032 | A mechanical rear derailleur may have been fitted instead of an electronic one. | The pedal assistance provided in the WALK level of assistance is possibly less than normal. | <ul style="list-style-type: none"> ▶ Re-fit the front derailleur for which the system is designed. ▶ Contact your specialist dealer if the problem persists. |

Table 40: List of warnings

10.3 Error message screen

If an error message is shown over the entire display, follow the procedure indicated below to reset the screen.

- ▶ Press the **On-Off button (battery)**.
- ▶ Take the battery from the mount.

Contact your specialist dealer if the problem persists.

| Code | Cause | Limitation | Remedy |
|------|--|--|---|
| E010 | A system error has been detected. | No pedal assistance is provided during the ride. | <ul style="list-style-type: none"> ▶ Press the On-Off button (battery). ▶ Contact your specialist dealer if the problem persists. |
| E011 | An error has occurred during system operation. | No pedal assistance is provided during the ride. | <ul style="list-style-type: none"> ▶ Switch the system on again. |

Table 41: List of warnings

Appendix

| Code | Cause | Limitation | Remedy |
|------|---|--|---|
| E013 | An anomaly has been detected in the firmware. | No pedal assistance is provided during the ride. | ▶ Contact your specialist dealer. |
| E014 | The speed sensor may have been installed incorrectly. | No pedal assistance is provided during the ride. | ▶ Contact your specialist dealer. |
| E020 | A communication error has been detected between the battery and the drive unit. | No pedal assistance is provided during the ride. | ▶ Check that the cable between the drive unit and the battery is connected properly. ▶ Contact your specialist dealer if the problem persists. |
| E021 | The battery connected to the drive unit meets the system standard but is not supported. | No pedal assistance is provided during the ride. | ▶ Press the On-Off button (battery). ▶ Contact your specialist dealer if the problem persists. |
| E022 | The battery connected to the drive unit does not meet the system standard. | Switch-off of all system functions. | ▶ Press the On-Off button (battery). ▶ Contact your specialist dealer if the problem persists. |
| E033 | The current firmware does not support system operation. | No pedal assistance is provided during the ride. | ▶ Contact your specialist dealer. |
| E043 | The display firmware may have been corrupted. | No pedal assistance is provided during the ride. | ▶ Contact your specialist dealer. |

Table 41: List of warnings

10.4 EC declaration of conformity

Translation of the original EC declaration of conformity

The manufacturer:

ZEG Zweirad-Einkaufs-Genossenschaft eG
 Longericher Straße 2
 50739 Köln, Germany



hereby declares that the electrically power assisted cycles of types:

19-18-4022, 19-18-4027, 19-18-4028, 19-18-4023, 19-19-4001, 19-18-4025, 19-18-4024, 19-18-4028

year of manufacture 2018 and year of manufacture 2019,

comply with all applicable requirements of **Machinery Directive 2006/42/EC**. Furthermore, the electrically power assisted cycles comply with all applicable basic requirements of **Electromagnetic Compatibility Directive 2014/30/EU**.

The following standards were used: **EN ISO 12100:2010** Safety of machinery – General principles of design – Risk assessment and reduction, **EN 15194:2015**, Cycles – Electrically power assisted cycles – EPAC bicycles, **EN ISO 4210**, Cycles – Safety requirements for bicycles, **EN 11243:2016**, Cycles – Luggage carriers for bicycles – Requirements and test methods and **EN 82079 1:2012**, Preparation of instructions for use – Structuring, content and presentation – Part 1: General principles and detailed requirements.

Ms. Janine Otto (Technical Editor), c/o ZEG Zweirad-Einkaufs-Genossenschaft eG, Longericher Straße 2, 50739 Köln, Germany, is authorised to compile the technical documentation.

ZWEIRAD EXPERTEN GRUPPE

Cologne, 27/11/2018

Place, date and signature

Egbert Hageböck

-Chairman-

Appendix

10.5 Parts list

| Model | E-Core Evo AM RS Di2 27.5 |
|----------------------|----------------------------------|
| Display | Shimano SC-8000 |
| Rechargeable battery | 375 W (up to 750 W) |
| Chargers | BMZ |
| Brakes | Magura MT-7 |
| Rear derailleur | Shimano XT Di2 |
| Gears | 11 |
| Cassette | CS-M8000, 11-46 |
| Fork | Fox Factory 36 Air Boost |
| Damper | Fox Factory Float DPS |
| Telescopic seat post | Kind Shock Lev Si |
| Tyres and size | Magic Mary, 65-584 SnakeSkin TLE |
| Rims | DT-SWISS, HX 1501 Spline |
| Saddle | SR, VERVE 1212URN |
| Stem | KALLOY, AS-ML1 |
| Headset | FSA, ORBIT 1.5ZS |
| Handles | ERGON, GD1 |
| Pedals | Wellgo C-128 DU |

Table 42: Parts list for E-Core Evo AM RS Di2 27,5

Appendix

| Model | E-Core Evo Di2 27.5+ |
|----------------------|----------------------------------|
| Motor | E8000 |
| Display | Shimano SC-8000 |
| Rechargeable battery | 375 W (up to 750 W) |
| Chargers | BMZ |
| Brakes | Magura MT5/4 |
| Rear derailleur | Shimano XT Di2 |
| Gears | 11 |
| Cassette | CS-M8000, 11-46 |
| Fork | Fox Rhythm 34 Float Air Boost |
| Seat post | KALLOY, SP-368 |
| Tyres and size | Rocket Ron, 70-584 SnakeSkin TLE |
| Rims | SHEANG LIH, AS-35P-N |
| Saddle | JUSTEK, 2059DRN |
| Stem | KALLOY, AS-ML1 |
| Headset | FSA, ORBIT 1.5ZS |
| Handles | VELO, VLG-1682AD3 |
| Pedals | Wellgo C-128 DU |

Table 43: Parts list for E-Core Evo Di2 27.5+

Appendix

| Model | E-Core Evo Di2 29 |
|----------------------|----------------------------------|
| Motor | E8000 |
| Display | Shimano SC-8000 |
| Rechargeable battery | 375 W (up to 750 W) |
| Chargers | BMZ |
| Brakes | Magura MT5/4 |
| Rear derailleur | Shimano XT Di2 |
| Gears | 11 |
| Cassette | CS-M8000, 11-46 |
| Fork | Fox Rhythm 34 Float Air Boost |
| Seat post | KALLOY, SP-368 |
| Tyres and size | Rocket Ron, 57-622 SnakeSkin TLE |
| Rims | SHEANG LIH, AS-T30-N |
| Saddle | JUSTEK, 2059DRN |
| Stem | KALLOY, AS-ML1 |
| Headset | C.H., CH-6201TBW |
| Handles | ERGON, GD1 |
| Pedals | VP, Bulls 171206 |

Table 44: **Parts list for E-Core Evo Di2 29**

Appendix

| Model | E-Core Evo AM Di2 |
|----------------------|---------------------------------|
| Motor | E8000 |
| Display | Shimano SC-8000 |
| Rechargeable battery | 375 W (up to 750 W) |
| Chargers | BMZ |
| Brakes | Magura MT5 |
| Rear derailleur | Shimano XT Di2 |
| Gears | 11 |
| Cassette | CS-M8000, 11-46 |
| Fork | Fox Rhythm 36 Float Air Boost |
| Damper | Fox DPS Performance |
| Telescopic seat post | Kind Shock Lev S |
| Tyres and size | Nobby Nic, 70-584 SnakeSkin TLE |
| Rims | SHEANG LIH, AS-35P-N |
| Saddle | JUSTEK, RAMPAGE 1213URN |
| Stem | KALLOY, AS-ML1 |
| Headset | FSA, ORBIT 1.5ZS |
| Handles | ERGON, GD1 |
| Pedals | Wellgo C-128 DU |

Table 45: Parts list E-Core Evo AM Di2

Appendix

| Model | E-Core Evo EN Di2 |
|----------------------|----------------------------------|
| Motor | E8000 |
| Display | Shimano SC-8000 |
| Rechargeable battery | 375 W (up to 750 W) |
| Chargers | BMZ |
| Brakes | Shimano BR-M8020 |
| Rear derailleur | Shimano XT Di2 |
| Gears | 11 |
| Cassette | CS-M8000, 11-46 |
| Fork | RockShox Lyrik RC 29B Air Boost |
| Damper | Fox Float X2 Factory |
| Telescopic seat post | Kind Shock Lev S |
| Tyres and size | Magic Mary, 65-584 SnakeSkin TLE |
| Rims | DT-SWISS, HX 1501 Spline |
| Saddle | SR, VERVE 1212URN |
| Stem | KALLOY, AS-ML1 |
| Headset | FSA, ORBIT 1.5ZS |
| Handles | ERGON, GD1 |
| Pedals | Wellgo C-128 DU |

Table 46: **Parts list for E-Core Evo EN Di2**

Appendix

| Model | E-Core Evo 2 27.5+ |
|----------------------|-----------------------------------|
| Motor | E8000 |
| Display | Shimano SC-8000 |
| Rechargeable battery | 375 W (up to 750 W) |
| Chargers | BMZ |
| Brakes | Magura MT5/4 |
| Rear derailleur | Shimano Deore |
| Gears | 10 |
| Cassette | CS-HG500, 11-42 |
| Fork | Suntour Aion-35 LOR Air CTS Boost |
| Seat post | KALLOY, SP-368 |
| Tyres and size | Rocket Ron, 70-584 SnakeSkin TLE |
| Rims | SHEANG LIH, AS-35P-N |
| Saddle | JUSTEK, 2059DRN |
| Stem | KALLOY, AS-ML1 |
| Headset | C.H., CH-6201TBW |
| Handles | VELO, VLG-1682AD3 |
| Pedals | Wellgo C-288 DU |

Table 47: Parts list E-Core Evo 2 27.5+

Appendix

| Model | E-Core Evo TR2 |
|----------------------|-----------------------------------|
| Motor | E8000 |
| Display | Shimano SC-8000 |
| Rechargeable battery | 375 W (up to 750 W) |
| Chargers | BMZ |
| Brakes | Magura MT5/4 |
| Rear derailleur | Shimano Deore |
| Gears | 10 |
| Cassette | CS-HG500, 11-42 |
| Fork | Suntour Aion-35 LOR Air CTS Boost |
| Damper | Fox DPS Performance |
| Seat post | KALLOY, SP-368 |
| Tyres and size | Nobby Nic, 70-584 SnakeSkin TLE |
| Rims | SHEANG LIH, AS-35P-N |
| Saddle | JUSTEK, 2059DRN |
| Stem | KALLOY, AS-ML1 |
| Headset | C.H., CH-6201TBW |
| Handles | VELO, VLG-1812 D2 |
| Pedals | Wellgo C-288 DU |

Table 48: **Parts list E-Core Evo TR2**

Appendix

| Model | E-Core Evo 2 29 |
|----------------------|-----------------------------------|
| Motor | E8000 |
| Display | Shimano SC-8000 |
| Rechargeable battery | 375 W (up to 750 W) |
| Chargers | BMZ |
| Brakes | Magura MT5/4 |
| Rear derailleur | Shimano Deore |
| Gears | 10 |
| Cassette | CS-HG500, 11-42 |
| Fork | Suntour Aion-35 LOR Air CTS Boost |
| Damper | – |
| Telescopic seat post | – |
| Seat post | KALLOY, SP-368 |
| Tyres and size | Rocket Ron, 57-622 SnakeSkin TLE |
| Rims | SHEANG LIH, AS-30P-N |
| Saddle | JUSTEK, 2059DRN |
| Stem | KALLOY, AS-ML1 |
| Headset | C.H., CH-6201TBW |
| Handles | VELO, VLG-1682AD3 |
| Pedals | VP, Bulls 171206 |

Table 49: **Parts list E-Core Evo 2 29**

Table of figures

11 Table of figures

| | |
|------------|--|
| Figure 1: | Type plate, example, 18 |
| Figure 2: | Bicycle viewed from the right, E Core Evo TR2 used as example, 25 |
| Figure 3: | Detailed view of bicycle from rider position, example, 26 |
| Figure 4: | Components of the wheel – example showing front wheel, 27 |
| Figure 5: | Bicycle without suspension (1) and with suspension (2) when riding over an obstacle, 29 |
| Figure 6: | Example showing Suntour fork: The stem and handlebars are fastened to the fork shaft (1). The wheel is fastened to the quick release axle (6). Other elements: The compression setting (2), crown (3), Q-Loc (5), dust seal (6), fork end for quick release (7), stanchion (8) and spring (9), 30 |
| Figure 7: | Example showing a Yari fork – diagram with the operating elements: Air valve (1), valve cap (2) fork lock (3), quick release (4) and rebound damper adjuster (5) and the assembly groups: Air suspension fork (A), compression damper assembly group (B) and rebound damper assembly group (C), 31 |
| Figure 8: | Example showing FOX rear frame damper, 32 |
| Figure 9: | Example showing Suntour rear frame damper, 33 |
| Figure 10: | Bicycle brake system with a disc brake, example, 34 |
| Figure 11: | Diagram of mechanical drive system, 35 |
| Figure 12: | Diagram of electric drive system, 36 |
| Figure 13: | Details of integrated battery, starting at bottom, 38 |
| Figure 14: | Overview of the display with button (1) screen (2), 40 |
| Figure 15: | On-screen indicators overview, 40 |
| Figure 16: | Example: Warning W010, 41 |
| Figure 17: | Example: Error Message E010, 42 |
| Figure 18: | Operating element overview, 44 |
| Figure 19: | Fastening the transport securing device, 49 |
| Figure 20: | Fully inserting the axle, 58 |
| Figure 21: | Tightening the axle, 58 |
| Figure 22: | Pushing the quick release lever into the axle, 59 |
| Figure 23: | Tightening the securing screw, 59 |
| Figure 24: | Tightening the inserted axle, 60 |
| Figure 25: | Tightening the axle, 60 |
| Figure 26: | Pushing the axle into the hub, 62 |

 Table of figures

| | |
|------------|--|
| Figure 27: | Tightening the axle, 62 |
| Figure 28: | Pushing the quick release lever into the axle, 63 |
| Figure 29: | Securing the lever, 63 |
| Figure 30: | Perfect position for the clamping lever, 64 |
| Figure 31: | Adjusting the quick release clamping force, 64 |
| Figure 32: | Closed and opened flange, 66 |
| Figure 33: | Pushing the quick release in, 66 |
| Figure 34: | Adjusting the clamping, 67 |
| Figure 35: | Closing the quick release, 67 |
| Figure 36: | Pushing the quick release in, 68 |
| Figure 37: | Spacing between lever and fork leg, 69 |
| Figure 38: | Structure of quick release from rear with (1) axle nut lock, (2) axle nut securing screw, (3) directional arrow, (4) axle setting value and (5) axle nut, 69 |
| Figure 39: | Pushing the Kabolt axle in, 71 |
| Figure 40: | Horizontal saddle tilt, 75 |
| Figure 41: | Optimal saddle height, 76 |
| Figure 42: | Seat post quick release (3), 76 |
| Figure 43: | Detailed view of the seat post – examples of the minimum insertion depth marking, 77 |
| Figure 44: | The seat post activation lever can be mounted either on the left (1) or the right (2) side of the handlebars, 78 |
| Figure 45: | Knee cap perpendicular line, 79 |
| Figure 46: | Open (2) and closed (1) clamping lever on the stem; by.schulz speedlifter used as an example, 81 |
| Figure 47: | Pulling locking lever upwards; by.schulz speedlifter used as an example, 82 |
| Figure 48: | Using the twist knob (1) to adjust the pressure point, 84 |
| Figure 49: | Brake lever grip distance, 85 |
| Figure 50: | Using the setting screw (2) to adjust the distance from the brake lever to the handlebar grip (1), 86 |
| Figure 51: | Screw caps in different designs, 88 |
| Figure 52: | Negative deflection setting wheel on the suspension fork crown, 90 |
| Figure 53: | Suntour rebound adjuster (2) on the fork (1), 91 |
| Figure 54: | FOX rebound adjuster (1) on the fork, 95 |
| Figure 55: | Suntour rebound adjuster wheel (1) on the rear frame damper, 97 |
| Figure 56: | Suntour compression adjuster wheel (1) on the rear frame damper, 98 |
| Figure 57: | FOX rear frame damper, 100 |

Table of figures

- Figure 58: FOX rebound adjuster (1) on the rear frame damper, 101
Figure 59: Settings menu, 102
Figure 60: Positioning battery (1) on mount (2), 119
Figure 61: Closed key cover (1) and charge cap (2), 120
Figure 62: Removing and inserting the down tube battery, 121
Figure 63: LED light on the charger, 123
Figure 64: Front (2) and rear (1) brake lever; Shimano brake used as an example, 136
Figure 65: Suntour compression adjuster with the OPEN (1) and LOCK (2) positions, 137
Figure 66: FOX compression adjuster with the OPEN (1) and HARD (2) positions, 138
Figure 67: Suntour compression adjuster open (1), 139
Figure 68: Suntour compression adjuster closed (2), 139
Figure 69: FOX compression adjuster on the rear frame damper with the OPEN (1), MEDIUM (2) and HARD (3) positions, 140
Figure 70: Fine adjustment of the OPEN position is made using the adjuster (4), 140
Figure 71: Checking the chain and belt tension, 154
Figure 72: Adjusting the quick release clamping force, 159
Figure 73: Adjusting the quick release clamping force, 159
Figure 74: Dunlop valve with union nut (1) and rim nut (2), 160
Figure 75: Presta valve with valve insert (1), knurled nut (2) and rim nut (3), 161
Figure 76: Schrader valve with rim nut (1), 162
Figure 77: Brake lever (1) of the hydraulically operated rim brake with setting bolt (2), 165
Figure 78: Trailer sign, 175

12 List of tables

| | |
|-----------|--|
| Table 1: | Meanings of the signal words, 13 |
| Table 2: | Safety markings on the product, 14 |
| Table 3: | Area of use, 15 |
| Table 4: | Bicycle type, 15 |
| Table 5: | Information on the type plate, 16 |
| Table 6: | Simplified terms, 17 |
| Table 7: | Conventions, 17 |
| Table 8: | Identification number of the operating instructions, 19 |
| Table 9: | Battery technical data, 38 |
| Table 10: | Battery charge status, 39 |
| Table 11: | On-screen indicators overview, 40 |
| Table 12: | Symbols of the gear recommendation function, 41 |
| Table 13: | Battery charge status, 42 |
| Table 14: | Journey information, 43 |
| Table 15: | Overview of levels of assistance, 43 |
| Table 16: | Operating element overview, 44 |
| Table 17: | Bicycle technical data, 45 |
| Table 18: | Battery technical data, 45 |
| Table 19: | Emissions from the bicycle*, 45 |
| Table 20: | Tightening torque values, 46 |
| Table 21: | Storage temperature for batteries, the bicycle and charger, 50 |
| Table 22: | Working environment temperature, 52 |
| Table 23: | Handlebars clamping screw maximum tightening torque, 80 |
| Table 24: | Overview of Suntour forks, 87 |
| Table 25: | Filling pressure pump of the Suntour air forks, 89 |
| Table 26: | Filling pressure table of the FOX air fork, 93 |
| Table 27: | Filling pressure table of the FOX air fork, 102 |
| Table 28: | Journey information setting options, 103 |
| Table 29: | Journey information setting options, 105 |
| Table 30: | Beep signal setting options, 106 |
| Table 31: | Units of measure setting options, 107 |
| Table 32: | Units of measure setting options, 109 |
| Table 33: | Battery charge status, 124 |
| Table 34: | Journey information, 129 |
| Table 35: | Journey information setting options, 130 |
| Table 36: | Units of measure setting options, 163 |
| Table 37: | Error eradication using the code, 170 |

List of tables

| | |
|-----------|--|
| Table 38: | Accessories, 172 |
| Table 39: | Battery error messages, 178 |
| Table 40: | List of warnings, 179 |
| Table 41: | List of warnings, 179 |
| Table 42: | Parts list for E-Core Evo AM RS Di2 27,50 S 9, 182 |
| Table 43: | Parts list for E-Core Evo Di2 27.5+, 183 |
| Table 44: | Parts list for E-Core Evo Di2 29, 184 |
| Table 45: | Parts list E-Core Evo AM Di2, 185 |
| Table 46: | Parts list for E-Core Evo EN Di2, 186 |
| Table 47: | Parts list E-Core Evo 2 27.5+, 187 |
| Table 48: | Parts list E-Core Evo TR2, 188 |
| Table 49: | Parts list E-Core Evo 2 29, 189 |

13 Index

A

- Air chamber, 32
- Air valve
 - Fork, 31
 - Rear frame damper, 32
- Alternative equipment, 16
- Alternative version, 16
- Area of use, 15

B

- Back-pedal brake,
 - braking, 136
- Battery, 38
 - charging, 122
 - checking, 57
 - disposing of, 177
- Belt tension, 153
- Bicycle type, 15
- Bike stand, see Kickstand
- Brake calliper, 34
- Brake disc, 34
- Brake lever, 26
 - adjusting the pressure point 83
- Brake lining, 34
 - maintaining, 152
- Brake,
 - using the transport securing system, 49
- Break in operation, 51
 - carrying out, 51
 - preparing, 51

C

- Chain drive, 35
- Chain guard,
 - checking, 113
- Chain tension, 153
- Chain wheel, 35
- Chain, 25, 35
 - maintaining, 153
 - replacing, 166, 167
- Charge status indicator, 39
- Charger,
 - disposing of, 177
- Clamping force,
 - Checking the quick releases, 62
 - Setting the quick releases, 62

D

- Data sheet, 1
- Direction of travel, 35
- Display, 40
- Drive system, 35
 - switching off, 126
 - switching on, 125
- Driving light, 39
 - checking function, 113
 - replacing, 166, 167

E

- EC declaration of conformity, 181

F

- Fork lock,
 - Position, 31
- Fork, 27
 - Fork end, 27
 - structure, 30
- Frame number, 1
- Frame, 25
- Front wheel brake, 34
 - braking, 136
- Front wheel, see Wheel

G

- Gear recommendation, 41
- Gear shift twist grip, 26
 - checking, 152
- Gear shift,
 - maintaining, 152
 - switching, 131

H

- Handlebars, 25, 26
- Hub, 27

I

- Initial commissioning 55

J

- Journey information,
 - switching, 43, 129
- Maximum, 43, 129

L

- Level of assistance, 43, 44
 - selecting, 128
- ECO, 43
- SPORT, 43
- TOUR, 43
- TURBO, 43
- Lever, 32
- Lighting, see Driving light

M

- Mass, see Weight
- Minimum insertion depth marking, 77
- Model year, 18
- Model, 1
- Mudguards,
 - checking, 113

O

- On-screen indicator, 40, 175
- Operating status indicator, 39
- O-ring, 32

P

- Packaging, 54
- Pannier rack,
 - changing, 116
 - checking, 113
 - using, 115
- Parts list, 181
- Pedal, 35
- Push assist,
 - using, 127

Q

- Quick release,
 - Position, 31

R

- Rear frame damper,
 - structure, 32, 33
- Rear wheel brake, 34
- Rear wheel, see Wheel
- Rebound damper adjuster,
 - Position, 31
- Rim, 27
 - checking, 151
 - replacing, 166, 167
- Roller brake,
 - braking, 136

Index

- S**
- Saddle, 25
- changing the saddle tilt, 74
 - changing the seat length, 79
 - determining the saddle height, 75, 79
- Seat post, 25
- clamping, 83, 85, 90, 94, 105
- Setting wheel, 32
- Shifter,
- checking, 152
 - setting, 156, 162, 165
- Spoke, 27
- Storage, 49
- Storing, see Storage
- Suspension fork head, 27
- Suspension fork, 28, 29
- System message, 41
- System setting,
- changing, 102
- T**
- Transportation, 47
- Transporting, see Transportation
- Type number, 1, 18
- Tyre pressure, 1
- Tyre size, 1
- Tyres, 27
- checking, 151
 - replacing, 166, 167
- V**
- Valve cap, 31
- Valve, 27
- Dunlop valve, 27
 - Presta valve, 27
 - Schrader valve, 27
- W**
- Weight,
- permitted total weight, 18
 - Unladen weight, 1
- Wheel circumference, 1
- Wheel,
- maintaining, 151
- Winter break, see break in operation

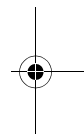
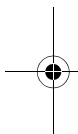

Text and images:
ZEG Zweirad-Einkaufs-Genossenschaft eG
Longericher Straße 2
50739 Köln, Germany

Translation:
Tanner Translations GmbH+Co
Markenstraße 7
40227 Düsseldorf, Germany

Operating instructions: 034-03224 • 1.0 • 11.12.2018

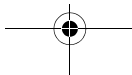



WWW.BULLS.DE

ZEG Zweirad-Einkaufs-Genossenschaft eG
Longericher Straße 2
50739 Köln, Germany
Tel.: +49 221 17959 0

YOUR BULLS SPECIALIST DEALER

